

COURSE MATERIAL

REFRIGERATION AND AIR CONDITIONING

B.Tech III Year II Semester

DEPARTMENT OF MECHANICAL ENGINEERING



Malla Reddy Engineering College
(Autonomous)

Maisammaguda, Dhulapally (Post. Via. Kompally), Secunderabad – 500 100.

Website: www.mrec.ac.in

Email: mehod@mrec.ac.in

2017-18 Onwards (MR-17)	MALLA REDDY ENGINEERING COLLEGE (Autonomous)	B.Tech. VI Semester		
Code: 70339	REFRIGERATION AND AIR CONDITIONING (Professional Elective – II)	L	T	P
Credits: 4		4	-	-

Prerequisites: Thermal Engineering-II

Course Objectives:

The objective of this subject is to provide basic knowledge about different refrigeration cycles, refrigeration systems, air conditioning and air cooler.

Codes/Tables: Refrigeration tables and Psychrometry charts

MODULE I: Introduction to Refrigeration & Air Refrigeration 14 Periods

Introduction to Refrigeration: Necessity and applications – Unit of refrigeration and C.O.P. – Mechanical Refrigeration – Types of Ideal cycles of refrigeration.

Air Refrigeration: Bell Coleman cycle or Reversed Brayton Cycle, Open and Dense air systems – Actual air refrigeration system problems – Refrigeration needs of Air craft's.

MODULE II: Principles of Evaporators & Vapour Compression Refrigeration. 14 Periods

Principles of Evaporators: Classification – Working Principles, Expansion devices – Types – Working Principles, Refrigerants – Desirable properties – classification - refrigerants used – Nomenclature

Vapour Compression Refrigeration: Working principle and essential components of the plant – simple Vapour compression refrigeration cycle – COP – Representation of cycle on T-S and p-h charts – effect of sub cooling and super heating – cycle analysis – Actual cycle - Influence of various parameters on system performance – Use of p-h charts – numerical Problems.

MODULE III: Vapor Absorption System & Steam Jet Refrigeration System. 12 Periods

A: Vapor Absorption System – Calculation of max COP – description and working of NH₃ – water system and Li Br –water (Two shell & Four shell) System. Principle of operation, Three Fluid absorption system, salient features.

B: Steam Jet Refrigeration System – Working Principle and Basic Components. Principle and operation of (i) Thermoelectric refrigerator (ii) Vortex tube or Hilsch tube.

MODULE IV: Introduction to Air Conditioning 12 Periods

Psychrometric Properties & Processes – Characterization of Sensible and latent heat loads - Need for Ventilation, Consideration of Infiltration – Load concepts of RSHF, GSHF- Problems, Concept of ESHF and ADP.

MODULE V: Requirements of Human Comfort and Concept of Effective Temperature & Air Conditioning systems 12 Periods

Requirements of human comfort and concept of effective temperature- Comfort chart – Comfort Air conditioning – Requirements of Industrial air conditioning, Air conditioning - Load Calculations.

Air Conditioning system - Classification of equipment, cooling, heating humidification and dehumidification, filters, grills and registers, fans and blowers. Heat Pump – Heat sources – different heat pump circuits.

TEXT BOOKS

1. C.P. Arora, “**Refrigeration & Air Conditioning**”, Tata McGraw-Hill Education, 3rd Edition, 2010.
2. S.C.Arora & Domkundwar “**A Course in Refrigeration and Air conditioning**”, Dhanpatrai Publications, 3rd edition, 1980.

REFERENCES

1. Manohar Prasad “**Refrigeration and Air Conditioning**” New Age International, 2nd Edition, 2003
2. Dossat “**Principles of Refrigeration**”, Pearson, 4th Edition, 2009.
3. P.L.Bellaney “**Refrigeration and Air Conditioning**”, Khanna Publishers, 6th edition, 2013.
4. P.N.Ananthanarayan “**Basic Refrigeration and Air Conditioning**” TMH, 4th Edition, 2013
5. R.S. Khurmi & J.K Gupta “**A Text Book of Refrigeration and Air Conditioning**”, S. Chand - Eurasia Publishing House (P) Ltd., 2008.

E - RESOURCES

1. <http://nptel.ac.in/courses/112105128/>
2. <http://nptel.ac.in/courses/112105129/>
3. <http://nptel.ac.in/courses/112107208/>
4. International Journal of Refrigeration.
5. International Journal of Air-Conditioning and Refrigeration.

Course Outcomes

At the end of the course, students will be able to

1. Understand different cycles in refrigeration.
2. Analyse the performance of vapour compression refrigeration.
3. Analyse the performance of vapour absorption system and steam jet refrigeration system.
4. Use the Psychrometry charts in air conditioning problems.
5. Understand the knowledge about the requirement of human comfort, requirement of industrial air conditioning and different types of air conditioning systems.

REFRIGERATION AND AIR CONDITIONING

MODULE-1

Refrigeration may be defined as the process of achieving and maintaining a temperature below that of the surroundings, the aim being to cool some product or space to the required temperature. One of the most important applications of refrigeration has been the preservation of perishable food products by storing them at low temperatures. Refrigeration systems are also used extensively for providing thermal comfort to human beings by means of air conditioning. Air Conditioning refers to the treatment of air so as to simultaneously control its temperature, moisture content, cleanliness, odour and circulation, as required by occupants, a process, or products in the space.

UNIT OF REFRIGERATION AND COP

The standard unit of refrigeration is ton of refrigeration or simply ton denoted by TR. It is defined as the amount of refrigeration effect produced by the uniform melting of one tonne (1000 kg) of ice from and at 0°C in 24 hours.

Since latent heat of ice is 335kJ/kg, therefore one tone of refrigeration,

1 TR= 1000 X 335 kJ in 24 hours.

$$\frac{1000 \times 335}{24 \times 60} = 232.6 \text{ kJ/min}$$

In actual practice one tone of refrigeration is taken as equivalent to 210kJ/min or

3.5kW (i.e 3.5kJ/s).

The major applications of refrigeration can be grouped into following four major equally important areas.

1. Food processing, preservation and distribution
2. Chemical and process industries
3. Special Applications
4. Comfort air-conditioning

Food processing, preservation and distribution

Storage of Raw Fruits and Vegetables:

Some bacteria are responsible for degradation of food, and enzymatic processing cause ripening of the fruits and vegetables. The growth of bacteria and the rate of enzymatic processes are reduced at low temperature. This helps in reducing the spoilage and improving the shelf life of the food. Table 3.1 shows useful storage life of some plant and animal tissues at various temperatures.

It can be seen that the storage temperature affects the useful storage life significantly. In general the storage life of most of the food products depends upon water activity, which essentially depends upon the presence of water in liquid form in the food product and its temperature. Hence, it is possible to preserve various food products for much longer periods under frozen conditions.

In case of fruits and vegetables, the use of refrigeration starts right after harvesting to remove the post-harvest heat, transport in refrigerated transport to the cold storage or the processing plant. A part of it may be stored in cold storage to maintain its sensory qualities and a part may be distributed to retail shops, where again refrigeration is used for short time storage. Depending upon the size, the required capacity of refrigeration plants for cold storages can be very high. Ammonia is one of the common refrigerants used in cold storages.

The cold chain has proved to be very effective in reducing spoilage of food and in food preservation. It is estimated that in India, the post-harvest loss due to inadequate cold storage facilities is high as 30 percent of the total output. The quality of remaining 70 percent is also affected by inadequate cold chain facilities. This shows the importance of proper refrigeration facilities in view of the growing food needs of the ever-growing population. Refrigeration helps in retaining the sensory, nutritional and eating qualities of the food. The excess crop of fruits and vegetables can be stored for use during peak demands and off-season; and transported to remote locations by refrigerated transport. In India, storage of potatoes and apples in large scale and some other fruits and vegetables in small scale and frozen storage of peas, beans, cabbage, carrots etc. has improved the standard of living. In general, the shelf life of most of the fruits and vegetables increases by storage at temperatures between 0 to 10 °C. Table 3.2 shows the typical storage conditions for some fruits and vegetables as recommended by ASHRAE. Nuts, dried fruits and pulses that are prone to bacterial deterioration can also be stored for long periods by this method. The above mentioned fruits, vegetables etc, can be stored in raw state. Some highly perishable items require initial processing before storage. The fast and busy modern day life demands ready-to-eat frozen or refrigerated food packages to eliminate the preparation and cooking time. These items are becoming very popular and these require refrigeration plants.

Fish:

In India, iced fish is still transported by rail and road, and retail stores store it for short periods by this method. Freezing of fish aboard the ship right after catch results in better quality than freezing it after the ship docks. In some ships, it is frozen along with seawater since it takes months before the ships return to dock. Long-term preservation of fish requires cleaning, processing and freezing.

Meat and poultry:

These items also require refrigeration right after slaughter during processing, packaging. Short-term storage is done at 0 °C. Long-term storage requires freezing and storage at -25 °C.

Dairy Products:

The important dairy products are milk, butter, buttermilk and ice cream. To maintain good quality, the milk is cooled in bulk milk coolers immediately after being taken from cow. Bulk milk cooler is a large refrigerated tank that cools it between 10 to 15°C. Then it is transported to dairy farms, where it is pasteurized. Pasteurization involves heating it to 73°C and holding it at this temperature for 20 seconds. Thereafter, it is cooled to 3 to 4°C. The dairies have to have a very large cooling capacity, since a large quantity of milk has to be immediately cooled after arrival. During the lean period, the refrigeration plants of dairies are used to produce ice that is used during peak periods to provide cooling by melting. This reduces the required peak capacity of the refrigeration plant.

Ice cream manufacture requires pasteurization, thorough mixing, emulsification and stabilization and subsequently cooling to 4 to 5°C. Then it is cooled to temperature of about – 5 °C in a freezer where it stiffens but still remains in liquid state. It is packaged and hardened at –30 to –25°C until it becomes solid; and then it is stored at same temperature.

Buttermilk, curd and cottage cheese are stored at 4 to 10 °C for increase of shelf life. Use of refrigeration during manufacture of these items also increases their shelf life.

Beverages:

Production of beer, wine and concentrated fruit juices require refrigeration. The taste of many drinks can be improved by serving them cold or by adding ice to them. Natural or man-made ice for this purpose has been made available since a very long time. Fruit juice concentrates have been very popular because of low cost, good taste and nutritional qualities. Juices can be preserved for a longer period of time than the fruits. Also, fruit juice concentrates when frozen can be more easily shipped and transported by road. Orange and other citrus juices, apple juice, grape juice and pineapple juice are very popular. To preserve the taste and flavor of juice, the water is driven out of it by boiling it at low temperature under reduced pressure. The concentrate is frozen and transported at –20°C.

Brewing and wine making requires fermentation reaction at controlled temperature, for example lager-type of beer requires 8 to 12°C while wine requires 27-30°C. Fermentation is an exothermic process; hence heat has to be rejected at controlled temperature.

Candy:

Use of chocolate in candy or its coating with chocolate requires setting at 5-10 °C otherwise it becomes sticky. Further, it is recommended that it be stored at low temperature for best taste.

Processing and distribution of frozen food:

Many vegetables, meat, fish and poultry are frozen to sustain the taste, which nearly duplicates that of the fresh product. Freezing retains the sensory qualities of colour, texture and taste apart from nutritional qualities. The refrigeration systems for frozen food applications are very liberally designed, since the food items are frozen in shortest period of time. The sharp freezing with temperature often below –30 °C, is done so that the ice crystals formed during freezing do not get sufficient time to grow and remain small and do not pierce the cell boundaries and damage them. Ready-to-eat frozen foods, packed dinners and bakery items are also frozen by this method and stored at temperatures of –25 to –20 °C for distribution to retail stores during peak demands or off-season demands.

Vegetables in this list are beans, corn, peas, carrots, cauliflower and many others. Most of these are blanched before freezing. There are various processes of freezing. *Blast freezers* give a blast of high velocity air at –30 °C on the food container. In *contact freezing*, the food is placed between metal plates and metal surfaces that are cooled to –30 °C or lower. *Immersion freezing* involves immersion of food in low temperature brine. *Individual quick freezing* (IQF) is done by chilled air at very high velocities like 5-10 m/s that keeps the small vegetable particles or shrimp pieces floating in air without clumping, so that maximum area is available for heat transfer to individual particles. The frozen particles can be easily packaged and transported. The refrigeration capacities in all the freezers are very large since freezing of large quantities is done in a very short time. Liquid nitrogen and carbon dioxide are also used for freezing.

Supermarket refrigeration is gaining popularity all over the world. At present this constitutes the largest sector of refrigeration in developed countries. In a typical supermarket a large

variety of products are stored and displayed for sale. Since a wide variety of products are stored, the required storage conditions vary widely. Refrigeration at temperatures greater than 0°C and less than 0°C is required, as both frozen and fresh food products are normally stored in the same supermarket. Refrigeration systems used for supermarkets have to be highly reliable due to the considerable value of the highly perishable products.

Applications of refrigeration in chemical and process industries

The industries like petroleum refineries, petrochemical plants and paper pulp industries etc. require very large cooling capacities. The requirement of each industry-process wise and equipment-wise is different hence refrigeration system has to be customized and optimized for individual application. The main applications of refrigeration in chemical and process industries involve the following categories.

Separation of gases:

In petrochemical plant, temperatures as low as -150°C with refrigeration capacities as high as 10,000 Tons of Refrigeration (TR) are used for separation of gases by fractional distillation. Some gases condense readily at lower temperatures from the mixtures of hydrocarbon. Propane is used as refrigerant in many of these plants.

Condensation of Gases:

Some gases that are produced synthetically, are condensed to liquid state by cooling, so that these can be easily stored and transported in liquid state. For example, in synthetic ammonia plant, ammonia is condensed at -10 to 10°C before filling in the cylinders, storage and shipment. This low temperature requires refrigeration.

Dehumidification of Air:

Low humidity air is required in many pharmaceutical industries. It is also required for air liquefaction plants. This is also required to prevent static electricity and prevents short circuits in places where high voltages are used. The air is cooled below its dew point temperature, so that some water vapour condenses out and the air gets dehumidified.

Solidification of Solute:

One of the processes of separation of a substance or pollutant or impurity from liquid mixture is by its solidification at low temperature. Lubricating oil is dewaxed in petroleum industry by cooling it below -25°C . Wax solidifies at about -25°C .

Storage as liquid at low pressure:

Liquid occupies less space than gases. Most of the refrigerants are stored at high pressure. This pressure is usually their saturation pressure at atmospheric temperature. For some gases, saturation pressure at room temperature is very high hence these are stored at relatively low pressure and low temperature. For example natural gas is stored at 0.7 bar gauge pressure and -130°C . Heat gain by the cylinder walls leads to boiling of some gas, which is compressed, cooled and expanded back to 0.7 bar gauge.

Removal of Heat of Reaction:

In many chemical reactions, efficiency is better if the reaction occurs below room temperature. This requires refrigeration. If these reactions are exothermic in nature, then more refrigeration capacities are required. Production of viscose rayon, cellular acetate and synthetic rubber are some of the examples. Fermentation is also one of the examples of this.

Cooling for preservation: Many compounds decompose at room temperature or these evaporate at a very fast rate. Certain drugs, explosives and natural rubber can be stored for long periods at lower temperatures.

Recovery of Solvents:

In many chemical processes solvents are used, which usually evaporate after reaction. These can be recovered by condensation at low temperature by refrigeration system. Some of the examples are acetone in film manufacture and carbon tetrachloride in textile production

Special applications of refrigeration

In this category we consider applications other than chemical uses. These are in manufacturing processes, applications in medicine, construction units etc.

Cold Treatment of Metals: The dimensions of precision parts and gauge blocks can be stabilized by soaking the product at temperature around -90°C . The hardness and wear resistance of carburized steel can be increased by this process. Keeping the cutting tool at -100°C for 15 minutes can also increase the life of cutting tool. In deep drawing process the ductility of metal increases at low temperature. Mercury patterns frozen by refrigeration can be used for precision casting.

Medical: Blood plasma and antibiotics are manufactured by freeze-drying process where water is made to sublime at low pressure and low temperature. This does not affect the tissues of blood. Centrifuges refrigerated at -10°C , are used in the manufacture of drugs. Localized refrigeration by liquid nitrogen can be used as anesthesia also.

Ice Skating Rinks: Due to the advent of artificial refrigeration, sports like ice hockey and skating do not have to depend upon freezing weather. These can be played in indoor stadium where water is frozen into ice on the floor. Refrigerant or brine carrying pipes are embedded below the floor, which cools and freezes the water to ice over the floor.

Construction: Setting of concrete is an exothermic process. If the heat of setting is not removed the concrete will expand and produce cracks in the structure. Concrete may be cooled by cooling sand, gravel and water before mixing them or by passing chilled water through the pipes embedded in the concrete. Another application is to freeze the wet soil by refrigeration to facilitate its excavation.

Desalination of Water: In some countries fresh water is scarce and seawater is desalinated to obtain fresh water. Solar energy is used in some cases for desalination. An alternative is to freeze the seawater. The ice thus formed will be relatively free of salt. The ice can be separated and thawed to obtain fresh water.

Ice Manufacture: This was the classical application of refrigeration. Ice was manufactured in plants by dipping water containers in chilled brine and it used to take about 36 hours to freeze

all the water in cans into ice. The ice thus formed was stored in ice warehouses. Now that small freezers and icemakers are available. Hotels and restaurants make their own ice, in a hygienic manner. Household refrigerators also have the facility to make ice in small quantities. The use of ice warehouses is dwindling because of this reason. Coastal areas still have ice plants where it is used for transport of iced fish.

Application of air conditioning:

Air-conditioning is required for improving processes and materials apart from comfort air-conditioning required for comfort of persons. The life and efficiency of electronic devices increases at lower temperatures. Computer and microprocessor-based equipment also require air-conditioning for their efficient operation. Modern electronic equipment with Very Large Scale Integrated (VLSI) chips dissipates relatively large quantities of energy in a small volume. As a result, unless suitable cooling is provided, the chip temperature can become extremely high. As the computing power of computers increases, more and more cooling will be required in a small volume. Some supercomputers required liquid nitrogen for cooling.

Air-conditioning applications can be divided into two categories, namely, industrial and comfort air-conditioning.

3.5.1. Industrial Air-conditioning: The main purpose of industrial air conditioning systems is to provide conducive conditions so that the required processes can be carried out and required products can be produced. Of course, the industrial air conditioning systems must also provide at least a partial measure of comfort to the people working in the industries. The applications are very diverse, involving cooling of laboratories down to -40°C for engine testing to cooling of farm animals. The following are the applications to name a few.

Laboratories: This may involve precision measurement to performance testing of materials, equipment and processes at controlled temperature and relative humidity. Laboratories carrying out research in electronics and biotechnology areas require very clean atmosphere. Many laboratories using high voltage like in LASERS require very low humidity to avoid the sparking.

Printing: Some colour printing presses have one press for each colour. The paper passes from one press to another press. The ink of one colour must get dried before it reaches the second press, so that the colours do not smudge. And the paper should not shrink, so that the picture does not get distorted. This requires control over temperature as well humidity. Improper humidity may cause static electricity, curling and buckling of paper.

Manufacture of Precision Parts: If the metal parts are maintained at uniform temperature during manufacturing process, these will neither expand nor shrink, maintaining close tolerances. A lower relative humidity will prevent rust formation also. A speck of dust in a switch or relay can cause total or partial malfunction in spacecraft. The manufacture of VLSI chips, microprocessors, computers, aircraft parts, Micro-Electro Mechanical Systems (MEMS), nanomaterial fabrication and many areas of modern progress require a very clean atmosphere and proper control over humidity. Any impurity in the atmosphere will spoil the VLSI chips. The concept of Clean rooms has been introduced for such industries. In fact, all precision industries that use microprocessors require these clean rooms.

Textile Industry: The yarn in the textile industry is spun and it moves over spools at very high speeds in modern machines. It is very sensitive to humidity. The generation of static electricity should be avoided. Its flexibility and strength should not change. If it breaks during the process, the plant will have to be stopped and yarn repaired before restarting the plant.

Pharmaceutical Industries: In these industries to obtain sterile atmosphere, the airborne bacteria and dust must be removed in the air-conditioning system by filters. These industries require clean rooms. If capsules are made or used in the plant, then air has to be dry otherwise the gelatin of capsules will become sticky.

Photographic Material: The raw material used for filmmaking has to be maintained at low temperature, since it deteriorates at high temperature and humidity. The film also has to be stored at low temperature. The room where film is developed requires 100% replacement by fresh air of the air polluted by chemicals.

Farm Animals: The yield of Jersey cows decreases drastically during summer months. Low temperature results in more efficient digestion of food and increase in weight of cow and the milk yield. Animal barns have to be ventilated in any case since their number density is usually very large. In many countries evaporative cooling is used for creating comfort conditions in animal houses.

Computer Rooms: These require control of temperature, humidity and cleanliness. The temperature of around 25 °C and relative humidity of 50% is maintained in these rooms. The dust spoils the CD drives and printers etc.; hence the rooms have to be kept clean also by using micro filters in the air-conditioning system.

Power Plants: Most of the modern power plants are microprocessor controlled. In the earlier designs, the control rooms were very large and were provided with natural ventilation. These days the control rooms are very compact, hence these require air-conditioning for persons and the microprocessors.

Vehicular Air-conditioning: Bus, tram, truck, car, recreational vehicle, crane cabin, aircraft and ships all require air-conditioning. In bus, tram, aircraft and ship, the occupancy density is very high and the metabolic heat and water vapour generated by persons has to be rejected. The cooling load in these is very high and rapidly changes that provides a challenge for their design.

3.5.2. Comfort Air-Conditioning: Energy of food is converted into chemical energy for functioning of brain, lungs, heart and other organs and this energy is ultimately rejected to the surroundings. Also the internal organs require a temperature close to 35°C for their efficient operation, and regulatory mechanisms of human body maintain this temperature by rejecting appropriate amount of heat. Human beings do not feel comfortable if some extra effort is required by the body to reject this energy. The air temperature, humidity and velocity at which human body does not have to take any extra action, is called comfort condition. Comfort condition is also sometimes called as neutral condition.

Restaurants, theatres and other places of amusement require air-conditioning for the comfort of patrons. All places where, a large number of people assemble should have sufficient supply of fresh air to dilute CO₂ and body odours emitted by persons. In addition, people dissipate large quantities of heat that has to be removed by air-conditioning for the comfort of persons. These places have wide variation in air-conditioning load throughout the day. These have large number of persons, which add a lot of water vapour by respiration and perspiration. The food cooked and consumed also adds water vapour. This vapour has to be removed by air-conditioning plant. Hence, these buildings have large latent heat loads. Infiltration of warm outdoor is also large since the large number of persons enter and leave the building leading to entry of outdoor air with every door opening. Ventilation requirement is also very large.

Air-conditioning in stores and supermarkets attracts more customers, induces longer period of stay and thereby increases the sales. Supermarkets have frozen food section, refrigerated food section, dairy and brewage section, all of them requiring different temperatures. The refrigeration system has to cater to different temperatures, apart from air-conditioning. These places also have a wide variation in daily loads depending upon busy and lean hours, and holidays.

Large commercial buildings are a world of their own; they have their own shopping center, recreation center, gymnasium swimming pool etc. Offices have very high density of persons during office hours and no occupancy during off time. These buildings require integrated concept with optimum utilization of resources and services. These have security aspects, fire protection, emergency services, optimum utilization of energy all built-in. Modern buildings of this type are called intelligent buildings where air-conditioning requires large amount of energy and hence is the major focus.

Since persons have to spend a major part of their time within the building, without much exposure to outdoors, the concept of Indoor Air Quality (IAQ) has become very important. There are a large number of pollutants that are emitted by the materials used in the construction of buildings and brought into the buildings. IAQ addresses to these issues and gives recommendation for their reduction to safe limits. Sick building syndrome is very common in poorly designed air conditioned buildings due to inadequate ventilation and use of improper materials. The sick building syndrome is characterized by the feeling of nausea, headache, eye and throat irritation and the general feeling of being uncomfortable with the indoor environment. In developed countries this is leading to litigation also.

REFRIGERANTS

Primary and secondary refrigerants:

Fluids suitable for refrigeration purposes can be classified into primary and secondary refrigerants. Primary refrigerants are those fluids, which are used directly as working fluids, for example in vapour compression and vapour absorption refrigeration systems. When used in compression or absorption systems, these fluids provide refrigeration by undergoing a phase change process in the evaporator. As the name implies, secondary refrigerants are those liquids, which are used for transporting thermal energy from one location to other. Secondary refrigerants are also known under the name brines or antifreezes. Of course, if the operating temperatures are above 0°C , then pure water can also be used as secondary refrigerant, for example in large air conditioning systems. Antifreezes or brines are used when refrigeration is required at sub-zero temperatures. Unlike primary refrigerants, the secondary refrigerants do not undergo phase change as they transport energy from one location to other. An important property of a secondary refrigerant is its freezing point. Generally, the freezing point of a brine will be lower than the freezing point of its constituents. The temperature at which freezing of a brine takes place its depends on its concentration. The concentration at which a lowest temperature can be reached without solidification is called as eutectic point. The commonly used secondary refrigerants are the solutions of water and ethylene glycol, propylene glycol or calcium chloride. These solutions are known under the general name of brines.

Refrigerant selection criteria:

Selection of refrigerant for a particular application is based on the following requirements:

- i. Thermodynamic and thermo-physical properties
- ii. Environmental and safety properties, and
- iii. Economics

Thermodynamic and thermo-physical properties:

The requirements are:

a) Suction pressure: At a given evaporator temperature, the saturation pressure should be above atmospheric for prevention of air or moisture ingress into the system and ease of leak detection. Higher suction pressure is better as it leads to smaller compressor displacement

b) Discharge pressure: At a given condenser temperature, the discharge pressure should be as small as possible to allow light-weight construction of compressor, condenser etc.

c) Pressure ratio: Should be as small as possible for high volumetric efficiency and low power consumption

d) Latent heat of vaporization: Should be as large as possible so that the required mass flow rate per unit cooling capacity will be small

In addition to the above properties; the following properties are also important:

e) Isentropic index of compression: Should be as small as possible so that the temperature rise during compression will be small

f) Liquid specific heat: Should be small so that degree of subcooling will be large leading to smaller amount of flash gas at evaporator inlet

g) Vapour specific heat: Should be large so that the degree of superheating will be small

h) Thermal conductivity: Thermal conductivity in both liquid as well as vapour phase should be high for higher heat transfer coefficients

i) Viscosity: Viscosity should be small in both liquid and vapour phases for smaller frictional pressure drops

The thermodynamic properties are interrelated and mainly depend on normal boiling point, critical temperature, molecular weight and structure.

The normal boiling point indicates the useful temperature levels as it is directly related to the operating pressures. A high critical temperature yields higher COP due to smaller compressor superheat and smaller flash gas losses. On the other hand since the vapour pressure will be low when critical temperature is high, the volumetric capacity will be lower for refrigerants with high critical temperatures. This once again shows a need for trade-off between high COP and high volumetric capacity. It is observed that for most of the refrigerants the ratio of normal boiling point to critical temperature is in the range of 0.6 to 0.7. Thus the normal boiling point is a good indicator of the critical temperature of the refrigerant.

The freezing point of the refrigerant should be lower than the lowest operating temperature of the cycle to prevent blockage of refrigerant pipelines.

26.3.2. Environmental and safety properties:

Next to thermodynamic and thermophysical properties, the environmental and safety properties are very important. In fact, at present the environment friendliness of the refrigerant is a major factor in deciding the usefulness of a particular refrigerant. The important environmental and safety properties are:

a) Ozone Depletion Potential (ODP): According to the Montreal protocol, the ODP of refrigerants should be zero, i.e., they should be non-ozone depleting substances. Refrigerants having non-zero ODP have either already been phased-out (e.g. R 11, R 12) or will be phased-out in near-future (e.g. R22). Since ODP depends mainly on the presence of chlorine or bromine in the molecules, refrigerants having either chlorine (i.e., CFCs and HCFCs) or bromine cannot be used under the new regulations

b) Global Warming Potential (GWP): Refrigerants should have as low a GWP value as possible to minimize the problem of global warming. Refrigerants with zero ODP but a high value of GWP (e.g. R134a) are likely to be regulated in future.

c) Total Equivalent Warming Index (TEWI): The factor TEWI considers both direct (due to release into atmosphere) and indirect (through energy consumption) contributions of refrigerants to global warming. Naturally, refrigerants with as a low a value of TEWI are preferable from global warming point of view.

d) Toxicity: Ideally, refrigerants used in a refrigeration system should be non-toxic. However, all fluids other than air can be called as toxic as they will cause suffocation when their concentration is large enough. Thus toxicity is a relative term, which becomes meaningful only when the degree of concentration and time of exposure required to produce harmful effects are specified. Some fluids are toxic even in small concentrations. Some fluids are mildly toxic, i.e., they are dangerous only when the concentration is large and duration of exposure is long. Some refrigerants such as CFCs and HCFCs are non-toxic when mixed with air in normal condition. However, when they come in contact with an open flame or an electrical heating element, they decompose forming highly toxic elements (e.g. phosgene- COCl_2). In general the degree of hazard depends on:

- Amount of refrigerant used vs total space
- Type of occupancy

- Presence of open flames
- Odor of refrigerant, and
- Maintenance condition

Thus from toxicity point-of-view, the usefulness of a particular refrigerant depends on the specific application

e) Flammability: The refrigerants should preferably be non-flammable and non-explosive. For flammable refrigerants special precautions should be taken to avoid accidents.

Based on the above criteria, ASHRAE has divided refrigerants into six safety groups (A1 to A3 and B1 to B3). Refrigerants belonging to Group A1 (e.g. R11, R12, R22, R134a, R744, R718) are least hazardous, while refrigerants belonging to Group B3 (e.g. R1140) are most hazardous.

Other important properties are:

f) Chemical stability: The refrigerants should be chemically stable as long as they are inside the refrigeration system.

g) Compatibility with common materials of construction (both metals and non-metals)

h) Miscibility with lubricating oils: Oil separators have to be used if the refrigerant is not miscible with lubricating oil (e.g. ammonia). Refrigerants that are completely miscible with oils are easier to handle (e.g. R12). However, for refrigerants with limited solubility (e.g. R 22) special precautions should be taken while designing the system to ensure oil return to the compressor

i) Dielectric strength: This is an important property for systems using hermetic compressors. For these systems the refrigerants should have as high a dielectric strength as possible

j) Ease of leak detection: In the event of leakage of refrigerant from the system, it should be easy to detect the leaks.

Economic properties:

The refrigerant used should preferably be inexpensive and easily available.

Designation of refrigerants:

Figure shows the classification of fluids used as refrigerants in vapour compression refrigeration systems. Since a large number of refrigerants have been developed over the years for a wide variety of applications, a numbering system has been adopted to designate various refrigerants. From the number one can get some useful information about the type of refrigerant, its chemical composition, molecular weight etc. All the refrigerants are designated by **R** followed by a unique number.

i) Fully saturated, halogenated compounds:

These refrigerants are derivatives of alkanes ($C_n H_{2n+2}$) such as methane (CH_4), ethane (C_2H_6).

These refrigerants are designated by R_{XYZ}, where:

X+1 indicates the number of Carbon (C) atoms

Y-1 indicates number of Hydrogen (H) atoms, and Z indicates number of Fluorine atoms (F). The balance indicates the number of chlorine atoms.

Only 2 digits indicate that the value of X is zero.

Ex: R 22

$X = 0 \Rightarrow$ No. of Carbon atoms = $0+1 = 1 \Rightarrow$ derivative of methane (CH_4)

$Y = 2 \Rightarrow$ No. of Hydrogen atoms = $2-1 = 1$

$Z = 2 \Rightarrow$ No. of Fluorine atoms = 2

The balance = $4 - \text{no. of (H+F) atoms} = 4-1-2 = 1 \Rightarrow$ No. of Chlorine atoms = 1

\therefore The chemical formula of R 22 = CHClF_2

Similarly it can be shown that the chemical formula of:

$\text{R12} = \text{CCl}_2\text{F}_2$

$\text{R134a} = \text{C}_2\text{H}_2\text{F}_4$ (derivative of ethane)

(letter **a** stands for isomer, e.g. molecules having same chemical composition but different atomic arrangement, e.g. R134 and R134a)

ii) Inorganic refrigerants: These are designated by number 7 followed by the molecular weight of the refrigerant (rounded-off).

Ex.: Ammonia: Molecular weight is 17 \therefore the designation is R 717

Carbon dioxide: Molecular weight is 44 \therefore the designation is R 744

Water: Molecular weight is 18 \therefore the designation is R 718

iii) Mixtures: Azeotropic mixtures are designated by 500 series, where as zeotropic refrigerants (e.g. non-azeotropic mixtures) are designated by 400 series.

Azeotropic mixtures:

R 500: Mixture of R 12 (73.8 %) and R 152a (26.2%)

R 502: Mixture of R 22 (48.8 %) and R 115 (51.2%)

R503: Mixture of R 23 (40.1 %) and R 13 (59.9%)

R507A: Mixture of R 125 (50%) and R 143a (50%)

Zeotropic mixtures:

R404A : Mixture of R 125 (44%), R 143a (52%) and R 134a (4%)

R407A : Mixture of R 32 (20%), R 125 (40%) and R 134a (40%)

R407B : Mixture of R 32 (10%), R 125 (70%) and R 134a (20%)

R410A : Mixture of R 32 (50%) and R 125 (50%)

iv) Hydrocarbons:

Propane (C_3H_8) : R 290

n-butane (C_4H_{10}) : R 600

iso-butane (C_4H_{10}) : R 600a

Unsaturated Hydrocarbons: R1150 (C_2H_4)

R1270 (C_3H_6)

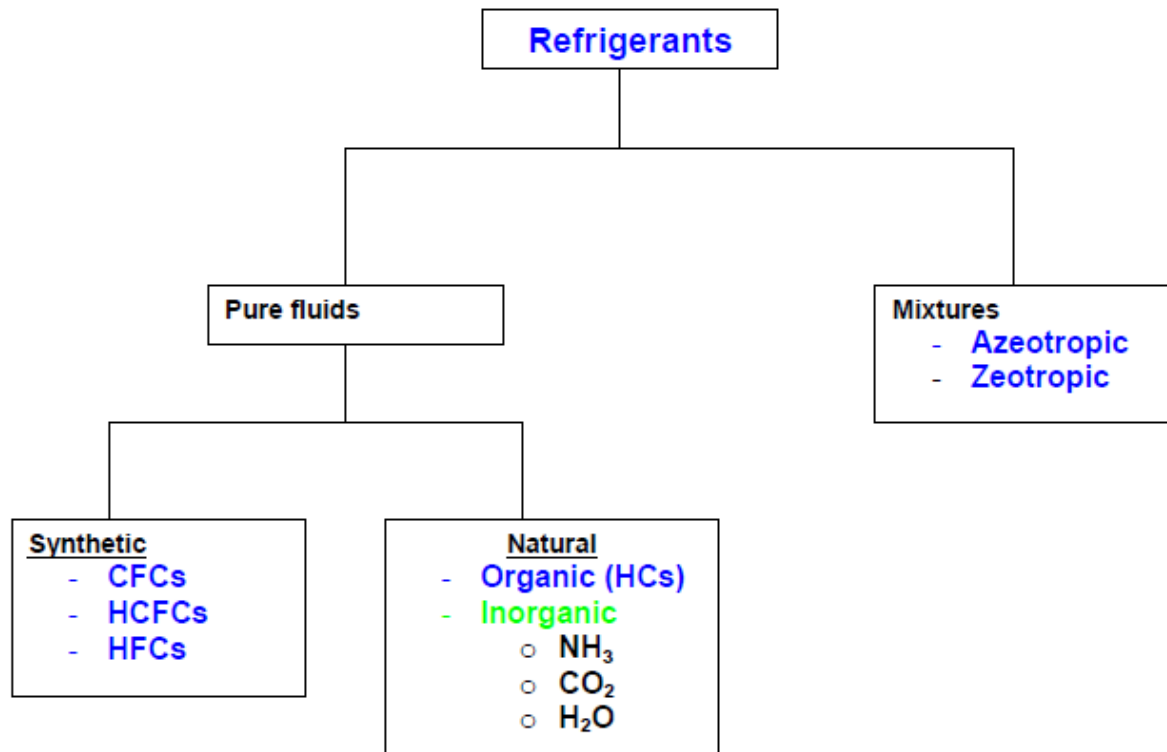

Refrigerant	Application	Substitute suggested Retrofit(R)/New (N)
R 11(CFC) NBP = 23.7°C h_{fg} at NBP=182.5 kJ/kg T_{cr} =197.98°C C_p/C_v = 1.13 ODP = 1.0 GWP = 3500	Large air conditioning systems Industrial heat pumps As foam blowing agent	R 123 (R,N)
		R 141b (N)
		R 245fa (N)
		n-pentane (R,N)
R 12 (CFC) NBP = -29.8°C h_{fg} at NBP=165.8 kJ/kg T_{cr} =112.04°C C_p/C_v = 1.126 ODP = 1.0 GWP = 7300	Domestic refrigerators Small air conditioners Water coolers Small cold storages	R 22 (R,N)
		R 134a (R,N)
		R 227ea (N)
		R 401A,R 401B (R,N)
		R 411A,R 411B (R,N)
R 717 (N)		
R 22 (HCFC) NBP = -40.8°C h_{fg} at NBP=233.2 kJ/kg T_{cr} =96.02°C C_p/C_v = 1.166 ODP = 0.05 GWP = 1500	Air conditioning systems Cold storages	R 410A, R 410B (N)
		R 417A (R,N)
		R 407C (R,N)
		R 507,R 507A (R,N)
		R 404A (R,N)
R 717 (N)		
R 134a (HFC) NBP = -26.15°C h_{fg} at NBP=222.5 kJ/kg T_{cr} =101.06°C C_p/C_v = 1.102 ODP = 0.0 GWP = 1200	Used as replacement for R 12 in domestic refrigerators, water coolers, automobile A/Cs etc	No replacement required * Immiscible in mineral oils * Highly hygroscopic
R 717 (NH₃) NBP = -33.35°C h_{fg} at NBP=1368.9 kJ/kg T_{cr} =133.0°C C_p/C_v = 1.31 ODP = 0.0 GWP = 0.0	Cold storages Ice plants Food processing Frozen food cabinets	No replacement required * Toxic and flammable * Incompatible with copper * Highly efficient * Inexpensive and available
R 744 (CO₂) NBP = -78.4°C h_{fg} at 40°C=321.3 kJ/kg T_{cr} =31.1°C C_p/C_v = 1.3 ODP = 0.0 GWP = 1.0	Cold storages Air conditioning systems Simultaneous cooling and heating (Transcritical cycle)	No replacement required * Very low critical temperature * Eco-friendly * Inexpensive and available

Refrigerant	Application	Substitute suggested Retrofit(R)/New (N)
R718 (H₂O) NBP = 100.°C h_{fg} at NBP=2257.9 kJ/kg T_{cr} =374.15°C C_p/C_v = 1.33 ODP = 0.0 GWP = 1.0	Absorption systems Steam jet systems	No replacement required * High NBP * High freezing point * Large specific volume * Eco-friendly * Inexpensive and available
R600a (iso-butane) NBP = -11.73°C h_{fg} at NBP=367.7 kJ/kg T_{cr} =135.0°C C_p/C_v = 1.086 ODP = 0.0 GWP = 3.0	Replacement for R 12 Domestic refrigerators Water coolers	No replacement required * Flammable * Eco-friendly

AIR CYCLE REFRIGERATION

Ideal reverse Brayton cycle

This is an important cycle frequently employed in gas cycle refrigeration systems. This may be thought of as a modification of reversed Carnot cycle, as the two isothermal processes of Carnot cycle are replaced by two isobaric heat transfer processes. This cycle is also called as Joule or Bell-Coleman cycle. Figure shows the schematic of a closed, reverse Brayton cycle and also the cycle on T-s diagram. As shown in the figure, the ideal cycle consists of the following four processes:

- Process 1-2: Reversible, adiabatic compression in a compressor
- Process 2-3: Reversible, isobaric heat rejection in a heat exchanger
- Process 3-4: Reversible, adiabatic expansion in a turbine
- Process 4-1: Reversible, isobaric heat absorption in a heat exchanger

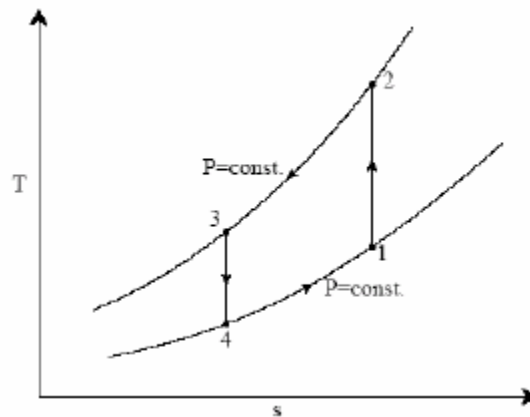
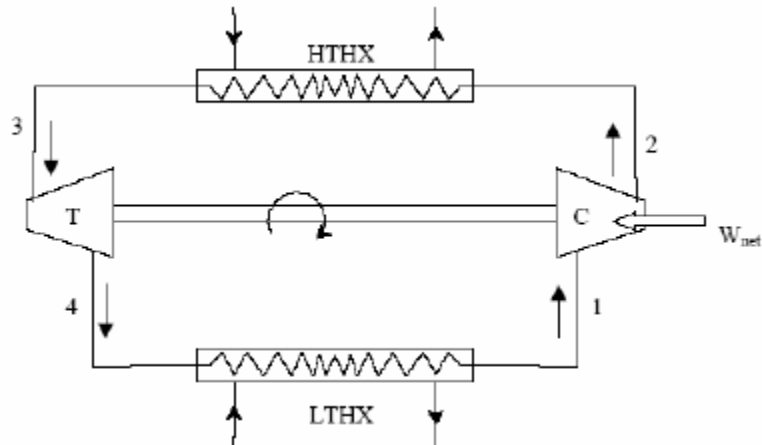

Process 1-2: Gas at low pressure is compressed isentropically from state 1 to state 2. Applying steady flow energy equation and neglecting changes in kinetic and potential energy, we can write:

$$W_{1-2} = m(h_2 - h_1) = m c_p (T_2 - T_1)$$

$$s_2 = s_1$$

$$\text{and } T_2 = T_1 \left(\frac{P_2}{P_1} \right)^{\frac{\gamma-1}{\gamma}} = T_1 r_p^{\frac{\gamma-1}{\gamma}}$$

where $r_p = (P_2/P_1) = \text{pressure ratio}$

Process 2-3: Hot and high pressure gas flows through a heat exchanger and rejects heat sensibly and isobarically to a heat sink. The enthalpy and temperature of the gas drop during the process due to heat exchange, no work transfer takes place and the entropy of the gas decreases. Again applying steady flow energy equation and second T ds equation:

$$Q_{2-3} = m(h_2 - h_3) = m c_p (T_2 - T_3)$$

$$s_2 - s_3 = c_p \ln \frac{T_2}{T_3}$$

$$P_2 = P_3$$

Process 3-4: High pressure gas from the heat exchanger flows through a turbine, undergoes isentropic expansion and delivers net work output. The temperature of the gas drops during the process from T_3 to T_4 . From steady flow energy equation:

$$W_{3-4} = m(h_3 - h_4) = m c_p (T_3 - T_4)$$

$$s_3 = s_4$$

$$\text{and } T_3 = T_4 \left(\frac{P_3}{P_4} \right)^{\frac{\gamma-1}{\gamma}} = T_4 r_p^{\frac{\gamma-1}{\gamma}}$$

where $r_p = (P_3/P_4)$ = pressure ratio

Process 4-1: Cold and low pressure gas from turbine flows through the low temperature heat exchanger and extracts heat sensibly and isobarically from a heat source, providing a useful refrigeration effect. The enthalpy and temperature of the gas rise during the process due to heat exchange, no work transfer takes place and the entropy of the gas increases. Again applying steady flow energy equation and second T ds equation:

$$Q_{4-1} = m(h_1 - h_4) = m c_p (T_1 - T_4)$$

$$s_4 - s_1 = c_p \ln \frac{T_4}{T_1}$$

$$P_4 = P_1$$

From the above equations, it can be easily shown that:

$$\left(\frac{T_2}{T_1} \right) = \left(\frac{T_3}{T_4} \right)$$

Applying 1st law of thermodynamics to the entire cycle:

$$\oint \delta q = (q_{4-1} - q_{2-3}) = \oint \delta w = (w_{3-4} - w_{1-2}) = -w_{\text{net}}$$

The COP of the reverse Brayton cycle is given by:

$$\text{COP} = \frac{|q_{4-1}|}{|w_{\text{net}}|} = \left(\frac{T_1 - T_4}{(T_2 - T_1) - (T_3 - T_4)} \right)$$

using the relation between temperatures and pressures, the COP can also be written as:

$$\text{COP} = \left(\frac{T_1 - T_4}{(T_2 - T_1) - (T_3 - T_4)} \right) = \left(\frac{T_4}{T_3 - T_4} \right) = \left(\frac{T_1 - T_4}{(T_1 - T_4)(r_p^{\frac{\gamma-1}{\gamma}} - 1)} \right) = (r_p^{\frac{\gamma-1}{\gamma}} - 1)^{-1}$$

Polytropic Compression:

If the compression process is polytropic with cooling, it would reduce the network of the cycle by reducing the average temperature of the compression process and the value of the compression index from γ to n . Then, the compressor work becomes:

$$W_{1-2} = \frac{n}{n-1} (p_2 v_2 - p_1 v_1) = \frac{n}{n-1} \frac{\gamma-1}{\gamma} C_p (T_2 - T_1)$$

The net work is

$$W = W_c - W_e$$

$$= C_p \left\{ \frac{n}{n-1} \frac{\gamma-1}{\gamma} (T_2 - T_1) - (T_3 - T_4) \right\}$$

And the COP is

$$\text{COP} = \frac{(T_1 - T_4)}{\frac{n}{n-1} \frac{\gamma-1}{\gamma} (T_2 - T_1) - (T_3 - T_4)}$$

Actual reverse Brayton cycle:

The actual reverse Brayton cycle differs from the ideal cycle due to:

- i. Non-isentropic compression and expansion processes
- ii. Pressure drops in cold and hot heat exchangers

Figure shows the ideal and actual cycles on T-s diagram. Due to these irreversibilities, the compressor work input increases and turbine work output reduces. The actual work transfer rates of compressor and turbine are then given by:

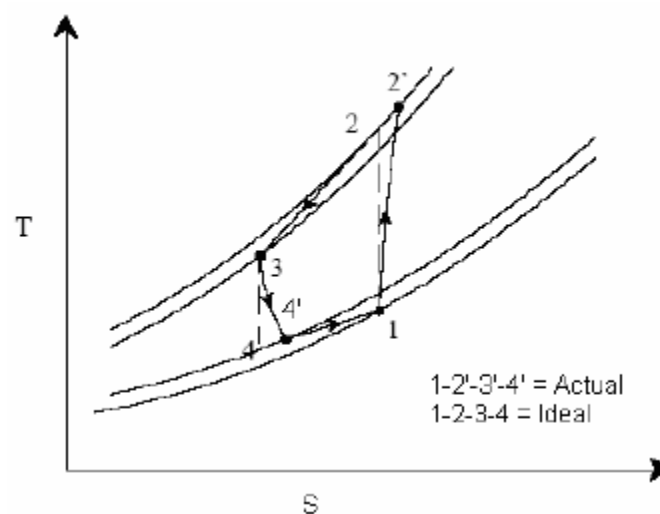

$$W_{1-2,act} = \frac{W_{1-2,isen}}{\eta_{c,isen}}$$

$$W_{3-4,act} = \eta_{t,isen} W_{3-4,isen}$$

where $\eta_{c,isen}$ and $\eta_{t,isen}$ are the isentropic efficiencies of compressor and turbine, respectively. In the absence of pressure drops, these are defined as:

$$\eta_{c,isen} = \frac{(h_2 - h_1)}{(h_{2'} - h_1)} = \frac{(T_2 - T_1)}{(T_{2'} - T_1)}$$

$$\eta_{t,isen} = \frac{(h_3 - h_4)}{(h_3 - h_{4'})} = \frac{(T_3 - T_4)}{(T_3 - T_{4'})}$$

The actual net work input, $w_{net,act}$ is given by:

$$W_{net,act} = W_{1-2,act} - W_{3-4,act}$$

thus the net work input increases due to increase in compressor work input and reduction in turbine work output. The refrigeration effect also reduces due to the irreversibilities. As a result, the COP of actual reverse Brayton cycles will be considerably lower than the ideal cycles. Design of efficient compressors and turbines plays a major role in improving the COP of the system.

In practice, reverse Brayton cycles can be open or closed. In open systems, cold air at the exit of the turbine flows into a room or cabin (cold space), and air to the compressor is taken from the cold space. In such a case, the low side pressure will be atmospheric. In closed systems, the same gas (air) flows through the cycle in a closed manner. In such cases it is possible to have low side pressures greater than atmospheric. These systems are known as *dense air systems*. Dense air systems are advantageous as it is possible to reduce the volume of air handled by the compressor and turbine at high pressures. Efficiency will also be high due to smaller pressure ratios. It is also possible to use gases other than air (e.g. helium) in closed systems.

Aircraft cooling systems

In an aircraft, cooling systems are required to keep the cabin temperatures at a comfortable level. Even though the outside temperatures are very low at high altitudes, still cooling of cabin is required due to:

- i. Large internal heat generation due to occupants, equipment etc.
- ii. Heat generation due to skin friction caused by the fast moving aircraft
- iii. At high altitudes, the outside pressure will be sub-atmospheric. When air at this low pressure is compressed and supplied to the cabin at pressures close to atmospheric, the temperature increases significantly. For example, when outside air at a pressure of 0.2 bar and temperature of 223 K (at 10000 m altitude) is compressed to 1 bar, its temperature increases to about 353 K. If the cabin is maintained at 0.8 bar, the temperature will be about 332 K. This effect is called as ram effect. This effect adds heat to the cabin, which needs to be taken out by the cooling system.

iv. Solar radiation

For low speed aircraft flying at low altitudes, cooling system may not be required, however, for high speed aircraft flying at high altitudes, a cooling system is a must.

Even though the COP of air cycle refrigeration is very low compared to vapour compression refrigeration systems, it is still found to be most suitable for aircraft refrigeration systems as:

- i. Air is cheap, safe, non-toxic and non-flammable. Leakage of air is not a problem

- ii. Cold air can directly be used for cooling thus eliminating the low temperature heat exchanger (open systems) leading to lower weight
- iii. The aircraft engine already consists of a high speed turbo-compressor, hence separate compressor for cooling system is not required. This reduces the weight per kW cooling considerably. Typically, less than 50% of an equivalent vapour compression system
- iv. Design of the complete system is much simpler due to low pressures. Maintenance required is also less.

Simple aircraft refrigeration cycle:

Figure shows the schematic of a simple aircraft refrigeration system and the operating cycle on T-s diagram. This is an open system. As shown in the T-s diagram, the outside low pressure and low temperature air (state 1) is compressed due to ram effect to ram pressure (state 2). During this process its temperature increases from 1 to 2. This air is compressed in the main compressor to state 3, and is cooled to state 4 in the air cooler. Its pressure is reduced to cabin pressure in the turbine (state 5), as a result its temperature drops from 4 to 5. The cold air at state 5 is supplied to the cabin. It picks up heat as it flows through the cabin providing useful cooling effect. The power output of the turbine is used to drive the fan, which maintains the required air flow over the air cooler. This simple system is good for ground cooling (when the aircraft is not moving) as fan can continue to maintain airflow over the air cooler.

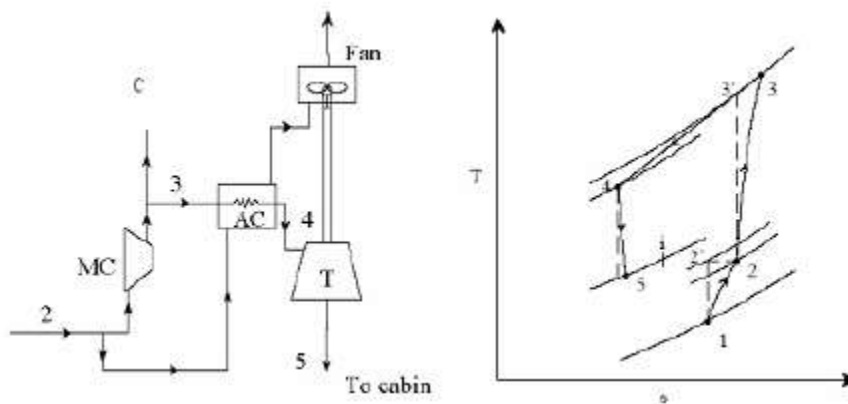

By applying steady flow energy equation to the ramming process, the temperature rise at the end of the ram effect can be shown to be:

$$\frac{T_2}{T_1} = 1 + \frac{\gamma - 1}{2} M^2$$

where M is the Mach number, which is the ratio of velocity of the aircraft (C) to the sonic velocity a

($a = \sqrt{\gamma RT_1}$), i.e.,

$$M = \frac{C}{a} = \frac{C}{\sqrt{\gamma RT_1}}$$

Due to irreversibilities, the actual pressure at the end of ramming will be less than the pressure resulting from isentropic compression. The ratio of actual pressure rise to the isentropic pressure rise is called as ram efficiency, η_{Ram} , i.e.,

$$\eta_{Ram} = \frac{(P_2 - P_1)}{(P_2' - P_1)}$$

The refrigeration capacity of the simple aircraft cycle discussed, is given by:

$$Q = \dot{m} c_p (T_1 - T_5)$$

where \dot{m} is the mass flow rate of air through the turbine.

MODULE-2

VAPOUR COMPRESSION REFRIGERATION SYSTEMS

Vapour compression refrigeration systems are the most commonly used among all refrigeration systems. As the name implies, these systems belong to the general class of vapour cycles, wherein the working fluid (refrigerant) undergoes phase change at least during one process. In a vapour compression refrigeration system, refrigeration is obtained as the refrigerant evaporates at low temperatures. The input to the system is in the form of mechanical energy required to run the compressor. Hence these systems are also called as mechanical refrigeration systems. Vapour compression refrigeration systems are available to suit almost all applications with the refrigeration capacities ranging from few Watts to few megawatts. A wide variety of refrigerants can be used in these systems to suit different applications, capacities etc. The actual vapour compression cycle is based on Evans-Perkins cycle, which is also called as reverse Rankine cycle.

Dry Versus Wet Compression

The compression process as shown in Fig. 3.1 involves the compression of wet-refrigerant vapour at $1'$ to dry-saturated vapour at $2'$. It is called *wet compression*. With a reciprocating compressor, wet compression is not found suitable due to the following reasons:

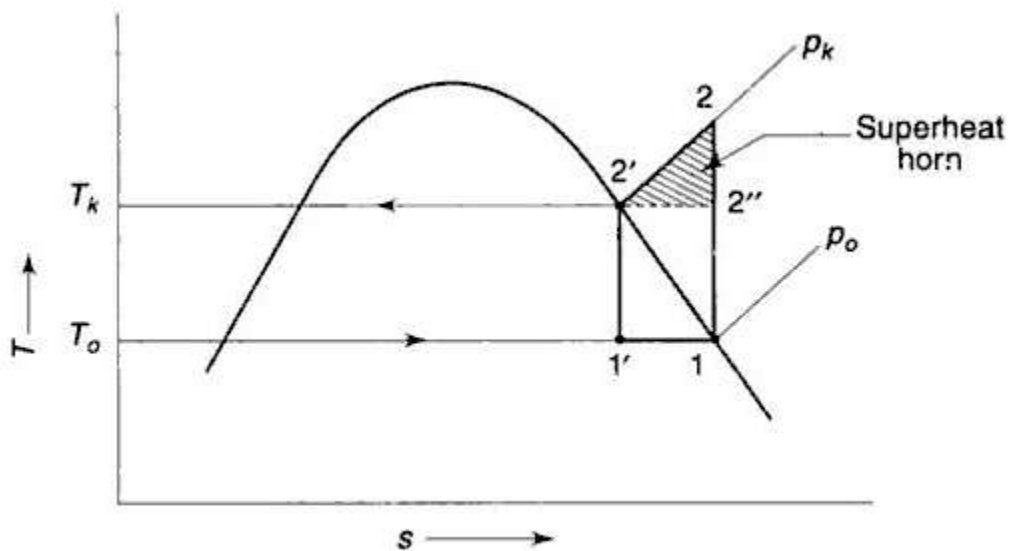

Fig. 3.1 Dry and Wet Compression Processes

- (i) First, liquid refrigerant may be trapped in the head of the cylinder and may damage the compressor valves and the cylinder itself. Even though the state of vapour at the end of wet compression is theoretically dry-saturated, it is normal to expect some liquid droplets to remain suspended in the gas, as the time taken by the compression process is quite small compared to the time needed for evaporation of droplets. For example, in a modern high-speed compressor, say, running at 2800 rpm, the time available in one revolution is only 0.021 second.
- (ii) Secondly, liquid-refrigerant droplets may wash away the lubricating oil from the walls of the compressor cylinder, thus increasing wear.

It is, therefore, desirable to have compression with vapour initially dry saturated at 1 as shown in Fig. 3.1, or even slightly superheated if a reciprocating compressor is used. Such compression is known as *dry compression*. The state of the vapour at the end of compression will, therefore, have to be at 2, at pressure p_k which is the saturation pressure of the refrigerant corresponding to the condensing temperature t_k , instead of being at 2', which would be the state point if the Carnot cycle were to be executed. It results in the discharge temperature t_2 being higher than the condensing temperature t_k . Consequently, the refrigerant leaves the compressor superheated. The increased work of the cycle due to the substitution of wet compression by dry compression appears as the area 2-2' - 2'', generally known as *superheat horn*.

Standard Vapour Compression Refrigeration System (VCRS)

Carnot refrigeration cycle is a completely reversible cycle, hence is used as a model of perfection for a refrigeration cycle operating between a constant temperature heat source and sink. It is used as reference against which the real cycles are compared.

As shown in Fig. the basic refrigeration system for pure vapour consists of four components: compressor, condenser, expansion device and evaporator. Refrigeration effect ($q_{4-1} = q_e$) is obtained at the evaporator as the refrigerant undergoes the process of vaporization (process 4-1) and extracts the latent heat from the low temperature heat source. The low temperature, low pressure vapour is then compressed isentropically in the compressor to the heat sink temperature T_c . The refrigerant pressure increases from P_e to P_c during the compression process (process 1-2) and the exit vapour is saturated. Next the high pressure, high temperature saturated refrigerant undergoes the process of condensation in the condenser (process 2-3) as it rejects the heat of condensation ($q_{2-3} = q_c$) to an external heat sink at T_c . The high pressure saturated liquid then flows through the expansion device and undergoes isenthalpic throttling (process 3-4). During this process, the pressure and temperature fall from P_c, T_c to P_e, T_e . Since a saturated liquid is expanded in the expansion device, some amount of liquid flashes into vapour and the exit condition lies in the two-phase region. This low temperature and low pressure liquid-vapour mixture then enters the evaporator completing the cycle.

Figure shows the schematic of a standard, saturated, single stage (SSS) vapour compression refrigeration system and the operating cycle on a T s diagram. As shown in the figure the standard single stage, saturated vapour compression refrigeration system consists of the following four processes:

Process 1-2: Isentropic compression of saturated vapour in compressor

Process 2-3: Isobaric heat rejection in condenser

Process 3-4: Isenthalpic expansion of saturated liquid in expansion device

Process 4-1: Isobaric heat extraction in the evaporator

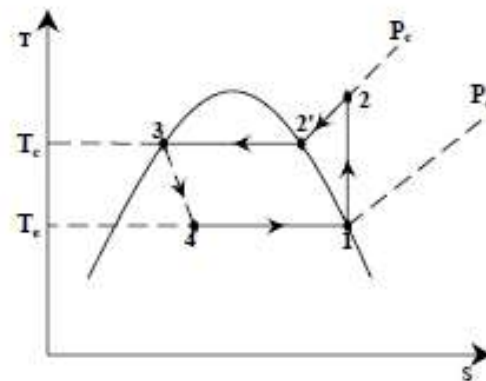
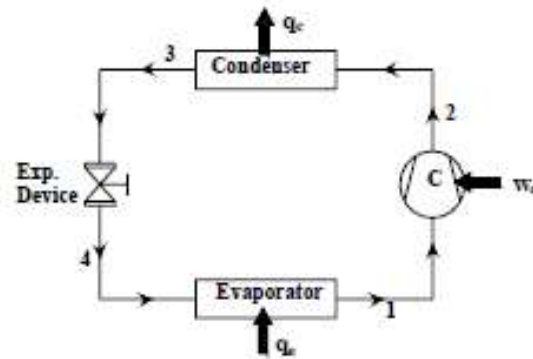

By comparing with Carnot cycle, it can be seen that the standard vapour compression refrigeration cycle introduces two irreversibilities:

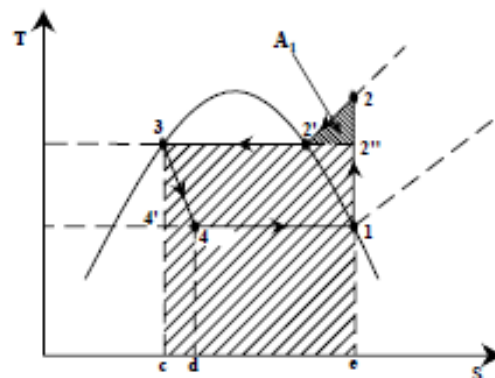

1) Irreversibility due to non-isothermal heat rejection (process 2-3) and
 2) Irreversibility due to isenthalpic throttling (process 3-4). As a result, one would expect the theoretical COP of standard cycle to be smaller than that of a Carnot system for the same heat source and sink temperatures. Due to these irreversibilities, the cooling effect reduces and work input increases, thus reducing the system COP. This can be explained easily with the help of the cycle diagrams on T s charts. Figure shows comparison between Carnot and standard VCRS in terms of refrigeration effect.

Figure show the schematic of a vapour compression refrigeration system and the operating cycle on p-v diagram.

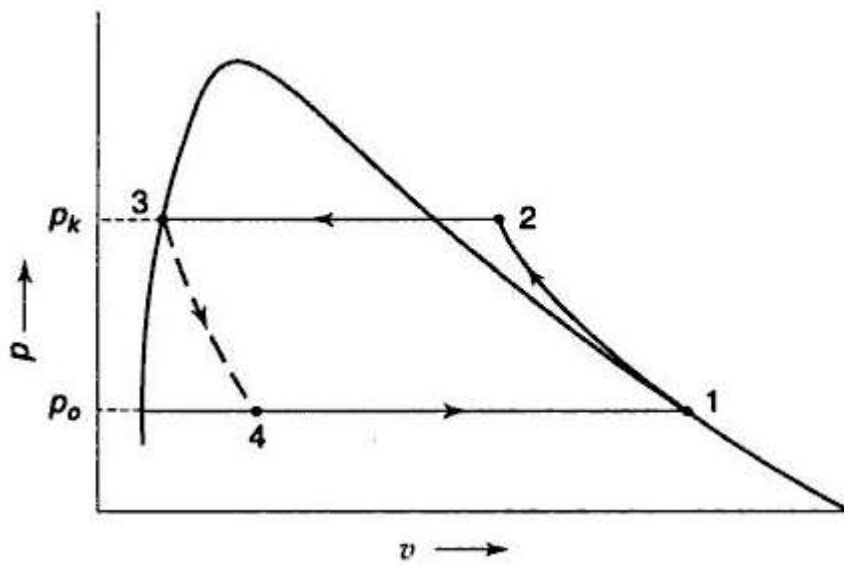

Comparison between Carnot and standard VCRS

The heat extraction (evaporation) process is reversible for both the Carnot cycle and VCRS cycle. Hence the refrigeration effect is given by:

For Carnot refrigeration cycle (1-2''-3-4'):

$$q_{e,Carnot} = q_{4'-1} = \int_{4'}^1 T \cdot ds = T_e (s_1 - s_{4'}) = \text{area } e-1-4'-c-e$$

For VCRS cycle (1-2-3-4):

$$q_{e,VCRS} = q_{4-1} = \int_4^1 T \cdot ds = T_e (s_1 - s_4) = \text{area } e-1-4-d-e$$

thus there is a reduction in refrigeration effect when the isentropic expansion process of Carnot cycle is replaced by isenthalpic throttling process of VCRS cycle, this reduction is equal to the area d-4-4'-c-d (area A_2) and is known as *throttling loss*. The throttling loss is equal to the enthalpy difference between state points 3 and 4', i.e,

$$q_{e,Carnot} - q_{VCRS} = \text{area } d-4-4'-c-d = (h_3 - h_{4'}) = (h_4 - h_{4'}) = \text{area } A_2$$

It is easy to show that the loss in refrigeration effect increases as the evaporator temperature decreases and/or condenser temperature increases. A practical consequence of this is a requirement of higher refrigerant mass flow rate.

The heat rejection in case of VCRS cycle also increases when compared to Carnot cycle.

As shown in Fig. the heat rejection in case of Carnot cycle (1-2''-3-4') is given by:

$$q_{c,Carnot} = -q_{2''-3} = -\int_{2''}^3 T \cdot ds = T_c (s_3 - s_{2''}) = \text{area } e-2''-3-c-e$$

In case of VCRS cycle, the heat rejection rate is given by:

$$q_{c,VCRS} = -q_{2-3} = -\int_2^3 T \cdot ds = \text{area } e-2-3-c-e$$

Hence the increase in heat rejection rate of VCRS compared to Carnot cycle is equal to the area 2''-2-2' (area A_1). This region is known as *superheat horn*, and is due to the replacement of isothermal heat rejection process of Carnot cycle by isobaric heat rejection in case of VCRS.

Since the heat rejection increases and refrigeration effect reduces when the Carnot cycle is modified to standard VCRS cycle, the net work input to the VCRS increases compared to Carnot cycle. The net work input in case of Carnot and VCRS cycles are given by:

$$W_{net,Carnot} = (q_c - q_e)_{Carnot} = \text{area } 1-2''-3-4'-1$$

$$W_{net,VCRS} = (q_c - q_e)_{VCRS} = \text{area } 1-2-3-4'-c-d-4-1$$

As shown in Fig. the increase in net work input in VCRS cycle is given by:

$$W_{\text{net, VCRS}} - W_{\text{net, Carnot}} = \text{area } 2''-2-2' + \text{area } c-4'-4-d-c = \text{area } A_1 + \text{area } A_2$$

ANALYSIS OF STANDARD VAPOUR COMPRESSION REFRIGERATION SYSTEM

A simple analysis of standard vapour compression refrigeration system can be carried out by assuming

- a) Steady flow; b) negligible kinetic and potential energy changes across each component, and
- c) no heat transfer in connecting pipe lines.

The steady flow energy equation is applied to each of the four components.

Evaporator: Heat transfer rate at evaporator or *refrigeration capacity* \dot{Q}_e is given by

$$\dot{Q}_e = \dot{m}_r (h_1 - h_4)$$

Where \dot{m}_r is the refrigerant mass flow rate in kg/s, h_1 and h_4 are the specific enthalpies (kJ/kg) at the exit and inlet to the evaporator, respectively. (h_1-h_4) is known as specific refrigeration effect or simply *refrigeration effect*, which is equal to the heat transferred at the evaporator per kilogram of refrigerant. The evaporator pressure P_e is the saturation pressure corresponding to evaporator temperature T_e , i.e.,

$$P_e = P_{\text{sat}}(T_e)$$

Compressor: Power input to the compressor, \dot{W}_c is given by

$$\dot{W}_c = \dot{m}_r (h_2 - h_1)$$

Where h_2 and h_1 are the specific enthalpies (kJ/kg) at the exit and inlet to the compressor, respectively. (h_2-h_1) is known as is known as specific work of compression or simply *work of compression*, which is equal to the work input to the compressor per kilogram of refrigerant..

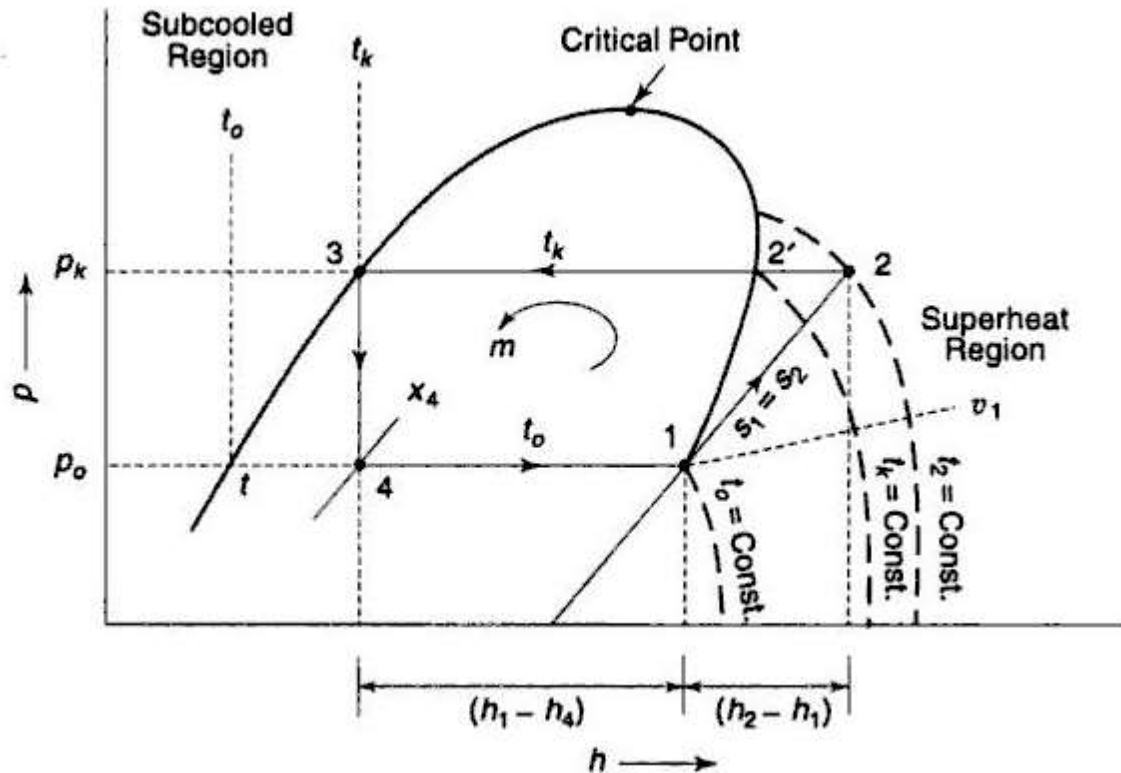

Condenser: Heat transfer rate at condenser, \dot{Q}_c is given by: $\dot{Q}_c = \dot{m}_r (h_2 - h_3)$
 Where h_3 and h_2 are the specific enthalpies (kJ/kg) at the exit and inlet to the condenser respectively. The condenser pressure P_c is the saturation pressure corresponding to condenser

temperature T_c , i.e., $P_c = P_{sat}(T_c)$

Expansion

Device: For the isenthalpic expansion process, the kinetic energy change across the expansion device is considerable. However, if we take the control volume, well downstream of the expansion

$$h_3 = h_4$$

device, then the kinetic energy gets dissipated due to viscous effects, and The exit condition of the expansion device lies in the two-phase region, hence applying the definition of quality or (dryness fraction), we can write:

$$h_4 = (1 - x_4)h_{f,e} + x_4h_{g,e} = h_f + x_4h_{fg}$$

Where

x_4 is the quality of refrigerant at 4, $h_{f,e}$, $h_{g,e}$, h_{fg} are the saturated liquid enthalpy, saturated vapour enthalpy and latent heat of vaporization at evaporator pressure respectively

The COP of the system is given by:

$$\text{COP} = \left(\frac{\dot{Q}_e}{\dot{W}_c} \right) = \left(\frac{\dot{m}_r (h_1 - h_4)}{\dot{m}_r (h_2 - h_1)} \right) = \frac{(h_1 - h_4)}{(h_2 - h_1)}$$

At any point in the cycle, the mass flow rate of refrigerant \dot{m}_r , can be written in terms of volumetric flow rate and specific volume at that point, i.e.

$$\dot{m}_r = \dot{V} / v$$

Applying this equation at the inlet condition of the compressor,

$$\dot{m}_r = \dot{V}_1 / v_1$$

Where V_1 is the volumetric flow rate at compressor inlet and v_1 is the specific volume at the compressor inlet.

Heat rejected, $q_k = q_o + w = h_2 - h_3$

COP for cooling, $\mathcal{E}_c = \frac{h_1 - h_4}{h_2 - h_1}$

COP for heating, $\mathcal{E}_h = \frac{h_2 - h_3}{h_2 - h_1}$

Refrigerant circulation rate, $\dot{m} = \frac{\text{refrigerating capacity}}{\text{refrigerating effect per unit mass}} = \frac{\dot{Q}_o}{q_o}$

Specific volume of the vapour at suction = v_1

Theoretical piston displacement of the compressor or volume of the suction vapour,

$$\dot{V} = \dot{m} v_1 \quad (3.8)$$

Actual piston displacement of the compressor,

$$\dot{V}_p = \frac{\dot{m} v_1}{\eta_v}$$

where η_v is the volumetric efficiency.

$$\text{Power consumption, } \dot{W} = \dot{m} w = \dot{m} (h_2 - h_1) \quad (3.9)$$

$$\text{Heat rejected in the condenser, } \dot{Q}_k = \dot{m} q_k = \dot{m} (h_2 - h_3) \quad (3.10)$$

Expressing the power consumption per ton of refrigeration as *unit power consumption*, denoted by \dot{W}^* , we have for mass flow rate and power consumption per ton refrigeration,

$$\dot{m}^* = \frac{3.5167}{q_o} \text{ kg/(s) \cdot (TR)} \quad (3.11)$$

$$\dot{W}^* = \dot{m}^* w = 3.5167 \left(\frac{h_2 - h_1}{h_1 - h_4} \right) \text{ kW/TR} \quad (3.12)$$

At a given compressor speed, v_1 is an indication of the size of the compressor. Generally the type of refrigerant, required refrigeration capacity, evaporator temperature and condenser temperature is known. Then from the condenser and evaporator temperature one can find the evaporator and condenser pressures and enthalpies at the exit of evaporator and condenser (saturated vapour enthalpy at evaporator pressure and saturated liquid enthalpy at condenser pressure). Since the exit condition of the compressor is in the superheated region, two independent properties are required to fix the state of refrigerant at this point. One of these independent properties could be the condenser pressure, which is already known. Since the compression process is isentropic, the entropy at the exit to the compressor is same as the entropy at the inlet, s_1 which is the saturated vapour entropy at evaporator pressure (known). Thus from the known pressure and entropy the exit state of the compressor could be fixed, i.e.,

$$h_2 = h(P_c, s_2) = h(P_c, s_1)$$

$$s_1 = s_2$$

The quality of the refrigerant at the inlet to the evaporator (x_4) could be obtained from the known values of h_3 , h_{fe} , h_e .

Once all the state points are known, then from the required refrigeration capacity and various enthalpies one can obtain the required refrigerant mass flow rate, volumetric flow rate at compressor inlet, COP, cycle efficiency etc.

Use of Pressure-enthalpy (P-h) charts:

Since the various performance parameters are expressed in terms of enthalpies, it is very convenient to use a pressure – enthalpy chart for property evaluation and performance analysis. The use of these charts was first suggested by Richard Mollier. Figure shows the standard vapour compression refrigeration cycle on a P-h chart. As discussed before, in a typical P-h chart, enthalpy is on the x-axis and pressure is on y-axis. The isotherms are almost vertical in the subcooled region, horizontal in the two-phase region (for pure refrigerants) and slightly curved in the superheated region at high pressures, and again become almost vertical at low pressures. A typical P-h chart also shows constant specific volume lines (isochors) and constant entropy lines (isentropes) in the superheated region. Using P-h charts one can easily find various performance parameters from known values of evaporator and condenser pressures.

In addition to the P-h and T-s charts one can also use thermodynamic property tables for solving problems related to various refrigeration cycles.

Subcooling:

In actual refrigeration cycles, the temperature of the heat sink will be several degrees lower than the condensing temperature to facilitate heat transfer. Hence it is possible to cool the refrigerant liquid in the condenser to a few degrees lower than the condensing temperature by adding extra area for heat transfer. In such a case, the exit condition of the condenser will be in the subcooled liquid region. Hence this process is known as *subcooling*.

Subcooling is beneficial as it increases the refrigeration effect by reducing the throttling loss at no additional specific work input. Also subcooling ensures that only liquid enters into the throttling device leading to its efficient operation. Figure shows the VCRS cycle without and with subcooling on P-h and T-s coordinates. It can be seen from the T-s diagram that without subcooling the throttling loss is equal to the hatched area **b-4'-4-c**, whereas with subcooling the throttling loss is given by the area **a-4''-4'-b**. Thus the refrigeration effect increases by an amount equal to $(h_4 - h_{4'}) = (h_3 - h_{3'})$. Another practical advantage of subcooling is that there is less vapour at the inlet to the evaporator which leads to lower pressure drop in the evaporator.

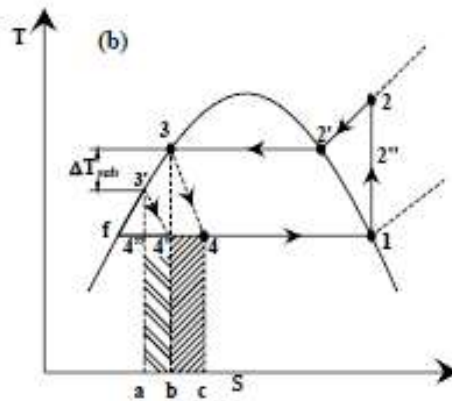
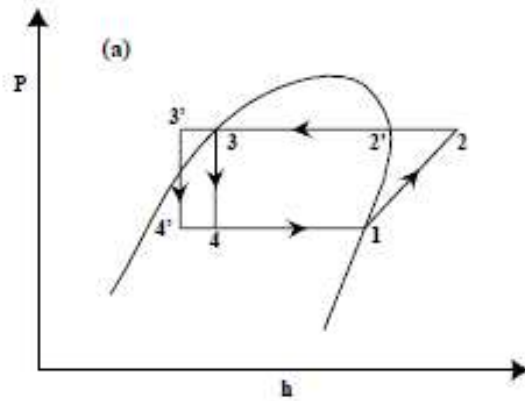

Superheating:

The temperature of heat source will be a few degrees higher than the evaporator temperature, hence the vapour at the exit of the evaporator can be superheated by a few degrees. If the superheating of refrigerant takes place due to heat transfer with the refrigerated space (low temperature heat source) then it is called as *useful superheating* as it increases the refrigeration effect.

On the other hand, it is possible for the refrigerant vapour to become superheated by exchanging heat with the surroundings as it flows through the connecting pipelines. Such a superheating is called as *useless superheating* as it does not increase refrigeration effect.

Useful superheating increases both the refrigeration effect as well as the work of compression. Hence the COP (ratio of refrigeration effect and work of compression) may or may not increase with superheat, depending mainly upon the nature of the working fluid. Even though useful superheating may or may not increase the COP of the system, a minimum amount of superheat is desirable as it prevents the entry of liquid droplets into the compressor. Figure shows the VCRS cycle with superheating on P-h and T-s coordinates. As shown in the figure, with useful superheating, the refrigeration effect, specific volume at the inlet to the compressor and work of compression increase.

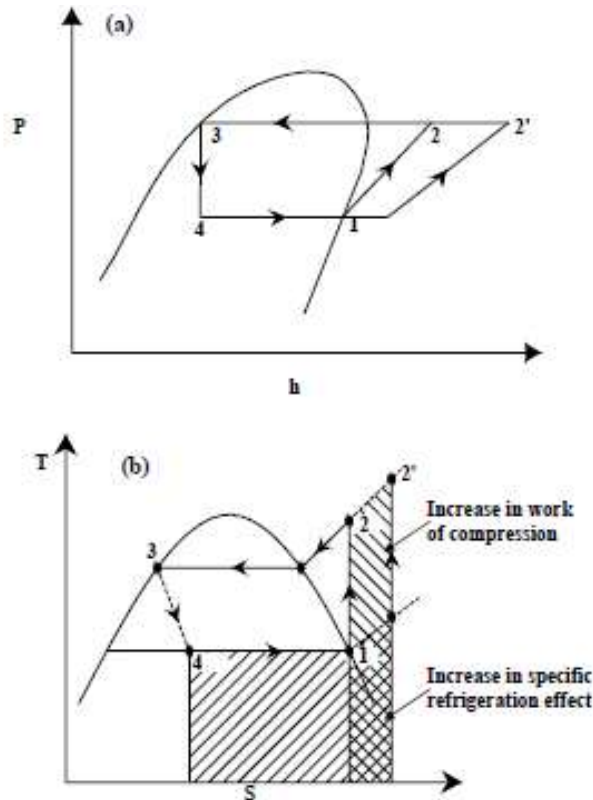

Whether the volumic refrigeration effect (ratio of refrigeration effect by specific volume at compressor inlet) and COP increase or not depends upon the relative increase in refrigeration effect and work of compression, which in turn depends upon the nature of the refrigerant used. The temperature of refrigerant at the exit of the compressor increases with superheat as the isentropes in the vapour region gradually diverge.

Even though superheat appears to be not desirable for refrigerants such as ammonia, still a minimum amount of superheat is provided even for these refrigerants to prevent the entry of refrigerant liquid into the compressor. Also it is observed experimentally that some amount of superheat is good for the volumetric efficiency of the compressor, hence in practice almost all the systems operate with some superheat.

Actual VCRS systems

The cycles considered so far are internally reversible and no change of refrigerant state takes place in the connecting pipelines. However, in actual VCRS several irreversibilities exist. These are due to:

1. Pressure drops in evaporator, condenser and LSHX
2. Pressure drop across suction and discharge valves of the compressor
3. Heat transfer in compressor
4. Pressure drop and heat transfer in connecting pipe lines

Figures shows the actual VCRS cycle on P-h and T-s diagrams indicating various irreversibilities. From performance point of view, the pressure drop in the evaporator, in the suction line and across the suction valve has a significant effect on system performance. This is due to the reason that as suction side pressure drop increases the specific volume at suction,

compression ratio (hence volumetric efficiency) and discharge temperature increase. All these effects lead to reduction in system capacity, increase in power input and also affect the life of the compressor due to higher discharge temperature. Hence this pressure drop should be as small as possible for good performance. The pressure drop depends on the refrigerant velocity, length of refrigerant tubing and layout (bends, joints etc.). Pressure drop can be reduced by reducing refrigerant velocity (e.g. by increasing the inner diameter of the refrigerant tubes), however, this affects the heat transfer coefficient in evaporator. More importantly a certain minimum velocity is required to carry the lubricating oil back to the compressor for proper operation of the compressor.

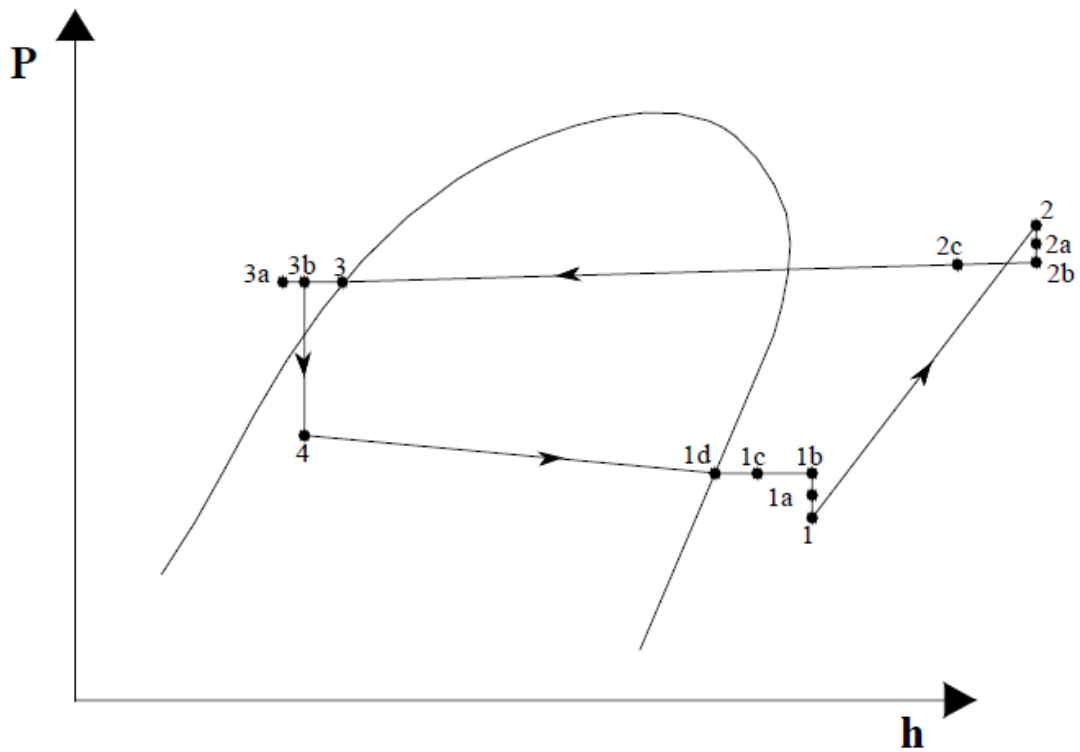

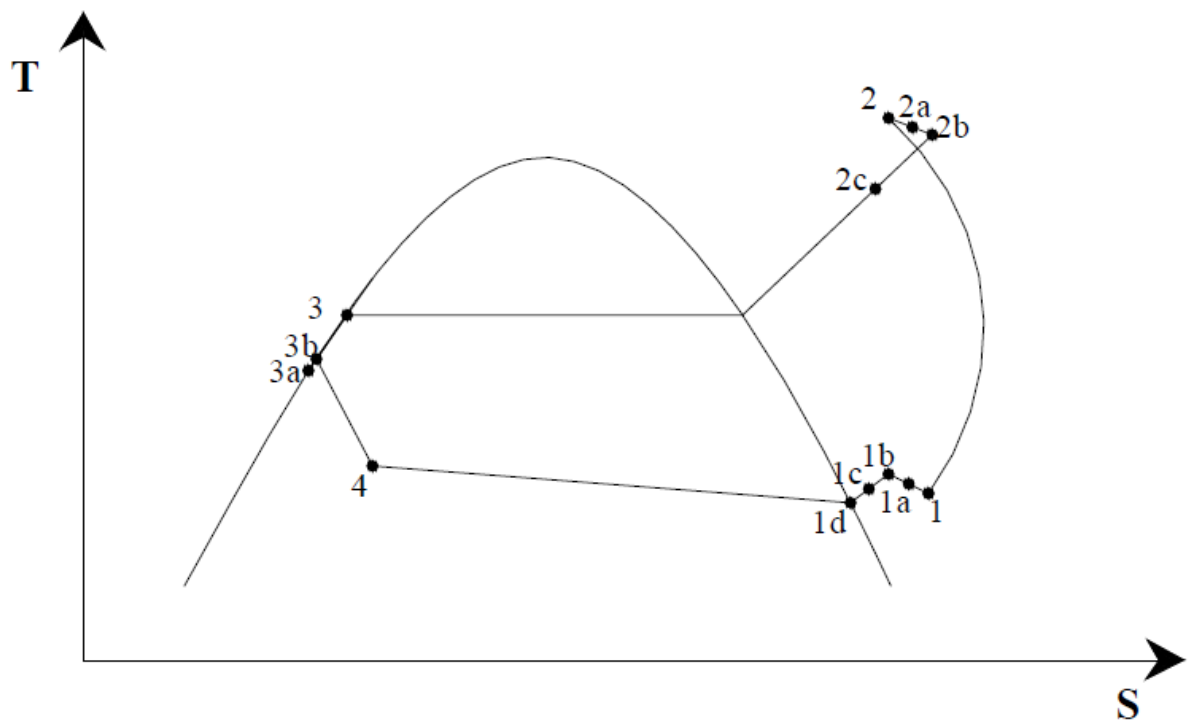

Process	State
Pressure drop in evaporator	4-1d
Superheat of vapour in evaporator	1d-1c
Useless superheat in suction line	1c-1b
Suction line pressure drop	1b-1a
Pressure drop across suction valve	1a-1
Non-isentropic compression	1-2
Pressure drop across discharge valve	2-2a
Pressure drop in the delivery line	2a-2b
Desuperheating of vapour in delivery pipe	2b-2c
Pressure drop in the condenser	2b-3
Subcooling of liquid refrigerant	3-3a
Heat gain in liquid line	3a-3b

Heat transfer in the suction line is detrimental as it reduces the density of refrigerant vapour and increases the discharge temperature of the compressor. Hence, the suction lines are normally insulated to minimize heat transfer.

In actual systems the compression process involves frictional effects and heat transfer. As a result, it cannot be reversible, adiabatic (eventhough it can be isentropic). In many cases

cooling of the compressor is provided deliberately to maintain the maximum compressor temperature within safe limits. This is particularly true in case of refrigerants such as ammonia. Pressure drops across the valves of the compressor increase the work of compression and reduce the volumetric efficiency of the compressor. Hence they should be as small as possible.

Compared to the vapour lines, the system is less sensitive to pressure drop in the condenser and liquid lines. However, this also should be kept as low as possible. Heat transfer in the condenser connecting pipes is not detrimental in case of refrigeration systems. However, heat transfer in the subcooled liquid lines may affect the performance.

In addition to the above, actual systems are also different from the theoretical cycles due to the presence of foreign matter such as lubricating oil, water, air, particulate matter inside the system. The presence of lubricating oil cannot be avoided, however, the system design must ensure that the lubricating oil is carried over properly to the compressor. This depends on the miscibility of refrigerant-lubricating oil. Presence of other foreign materials such as air (non-condensing gas), moisture, particulate matter is detrimental to system performance. Hence systems are designed and operated such that the concentration of these materials is as low as possible.

The COP of actual refrigeration systems is sometimes written in terms of the COP of Carnot refrigeration system operating between the condensing and evaporator temperatures (COP_{Carnot}), cycle efficiency (η_{cyc}), isentropic efficiency of the compressor (η_{is}) and efficiency of the electric motor (η_{motor}), as given by the equation shown below:

$$COP_{act} = \eta_{cyc} \eta_{is} \eta_{motor} COP_{Carnot}$$

The isentropic efficiency of the compressor (η_{is}) depends on several factors such as the compression ratio, design of the compressor, nature of the working fluid etc. However, in practice its value generally lies between 0.5 to 0.8. The motor efficiency (η_{motor}) depends on the size and motor load. Generally the motor efficiency is maximum at full load. At full load its value lies around 0.7 for small motors and about 0.95 for large motors.

Complete vapour compression refrigeration systems:

In addition to the basic components, an actual vapour compression refrigeration consists of several accessories for safe and satisfactory functioning of the system. These include: compressor controls and safety devices such as overload protectors, high and low pressure cutouts, oil separators etc., temperature and flow controls, filters, driers, valves, sight glass etc. Modern refrigeration systems have automatic controls, which do not require continuous manual supervision.

EVAPORATORS

An evaporator is a heat exchanger. In an evaporator, the refrigerant boils or evaporates and in doing so absorbs heat from the substance being refrigerated. The name evaporator refers to the evaporation process occurring in the heat exchanger.

Classification

There are several ways of classifying the evaporators depending upon the heat transfer process or refrigerant flow or condition of heat transfer surface.

Natural and Forced Convection Type

The evaporator may be classified as natural convection type or forced convection type.

In forced convection type, a fan or a pump is used to circulate the fluid being refrigerated and make it flow over the heat transfer surface, which is cooled by evaporation of refrigerant.

In natural convection type, the fluid being cooled flows due to natural convection currents arising out of density difference caused by temperature difference. The refrigerant boils inside tubes and evaporator is located at the top. The temperature of fluid, which is cooled by it, decreases and its density increases. It moves downwards due to its higher density and the warm fluid rises up to replace it.

Refrigerant Flow Inside or Outside Tubes

The heat transfer phenomenon during boiling inside and outside tubes is very different; hence, evaporators are classified as those with flow inside and outside tubes.

In natural convection type evaporators and some other evaporators, the refrigerant is confined and boils inside the tubes while the fluid being refrigerated flows over the tubes. The direct expansion coil where the air is directly cooled in contact with the tubes cooled by refrigerant boiling inside is an example of forced convection type of evaporator where refrigerant is confined inside the tubes.

In many forced convection type evaporators, the refrigerant is kept in a shell and the fluid being chilled is carried in tubes, which are immersed in refrigerant. Shell and tube type brine and water chillers are mainly of this kind.

Flooded and Dry Type

The third classification is flooded type and dry type. Evaporator is said to be flooded type if liquid refrigerant covers the entire heat transfer surface. This type of evaporator uses a float type of expansion valve. An evaporator is called dry type when a portion of the evaporator is used for superheating the refrigerant vapour after its evaporation.

Flooded Evaporator

This is typically used in large ammonia systems. The refrigerant enters a surge drum through a float type expansion valve. The compressor directly draws the flash vapour formed during expansion. This vapour does not take part in refrigeration hence its removal makes the evaporator more compact and pressured drop due to this is also avoided. The liquid refrigerant enters the evaporator from the bottom of the surge drum. This boils inside the tubes as heat is absorbed. The mixture of liquid and vapour bubbles rises up along the evaporator tubes. The vapour is separated as it enters the surge drum. The remaining unevaporated liquid circulates again in the tubes along with the constant supply of liquid refrigerant from the expansion valve.

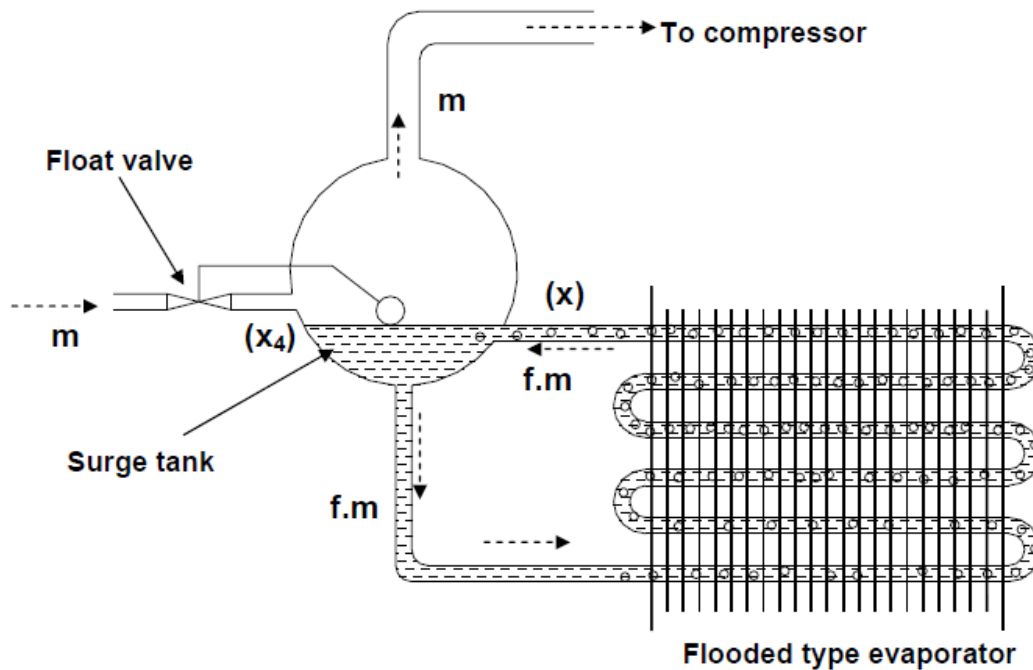

Since, liquid refrigerant is in contact with whole of evaporator surface, the refrigerant side heat transfer coefficient will be very high. Sometimes a liquid refrigerant pump may also be used to further increase the heat transfer coefficient. The lubricating oil tends to accumulate in the flooded evaporator hence an effective oil separator must be used immediately after the compressor.

Baudelot type evaporators

This type of evaporator consists of a large number of horizontal pipes stacked one on top of other and connected together to by headers to make single or multiple circuits. The refrigerant is circulated inside the tubes either in flooded or dry mode. The liquid to be chilled flows in a thin layer over the outer surface of the tubes. The liquid flows down by gravity from distributor pipe located on top of the horizontal tubes as shown in Figure. The liquid to be chilled is open to atmosphere, that is, it is at atmospheric pressure and its aeration may take place during cooling. This is widely used for cooling milk, wine and for chilling water for carbonation in bottling plants. The liquid can be chilled very close to its freezing temperature since freezing outside the tubes will not damage the tubes. Another advantage is

that the refrigerant circuit can be split into several parts, which permit a part of the cooling done by cold water and then chilling by the refrigerant.

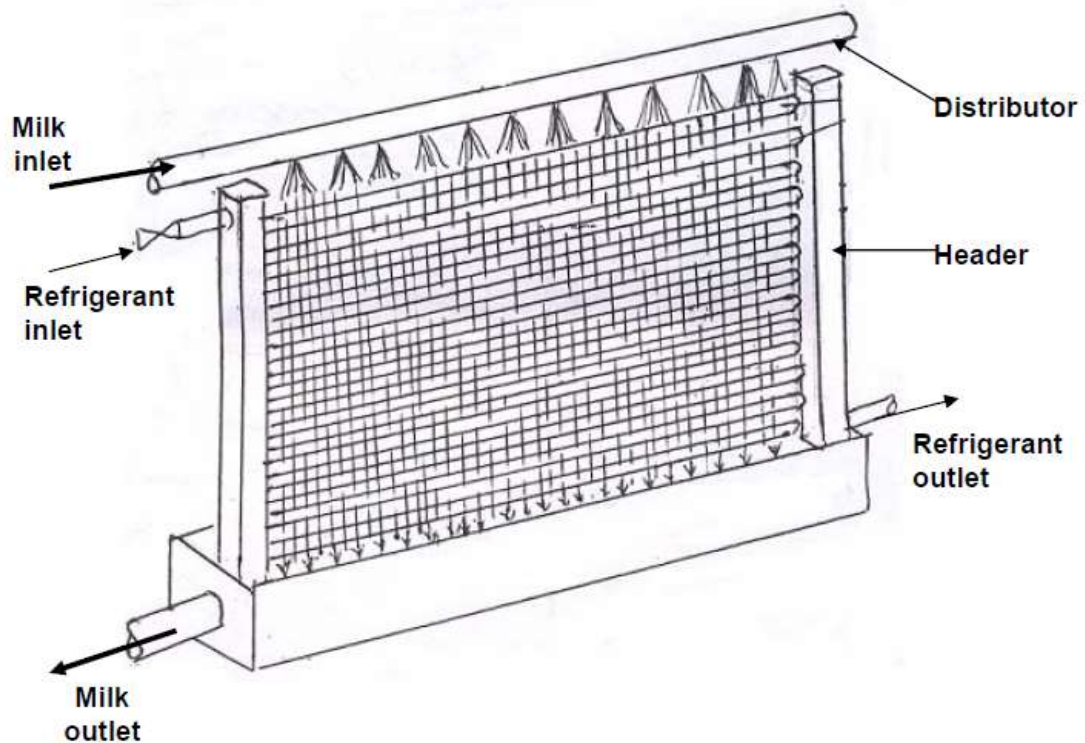

Direct expansion fin-and-tube type

These evaporators are used for cooling and dehumidifying the air directly by the refrigerant flowing in the tubes. Similar to fin-and-tube type condensers, these evaporator consists of coils placed in a number of rows with fins mounted on it to increase the heat transfer area. Various fin arrangements are used. Tubes with individual spiral straight fins or crimped fins welded to it are used in some applications like ammonia. Plate fins accommodating a number of rows are used in air conditioning applications with ammonia as well as synthetic refrigerants such as fluorocarbon based refrigerants.

The liquid refrigerant enters from top through a thermostatic expansion valve as shown in Fig. This arrangement makes the oil return to compressor better rather than feeding refrigerant from the bottom of the coil. When evaporator is close to the compressor, a direct expansion coil is used

since the refrigerant lines are short, refrigerant leakage will be less and pressure drop is small. If the air-cooling is required away from the compressor, it is preferable to chill water and pump it to air-cooling coil to reduce the possibility of refrigerant leakage and excessive refrigerant pressure drop, which reduces the COP.

The fin spacing is kept large for larger tubes and small for smaller tubes. 50 to 500 fins per meter length of the tube are used in heat exchangers. In evaporators, the atmospheric water vapour condenses on the fins and tubes when the metal temperature is lower than dew point temperature. On the other hand frost may form on the tubes if the surface temperature is less than 0°C . Hence for low temperature coils a wide spacing with about 80 to 200 fins per m is used to avoid restriction of flow passage due to frost formation. In air-conditioning applications a typical fin spacing of 1.8 mm is used. Addition of fins beyond a certain value will not increase the capacity of evaporator by restricting the airflow. The frost layer has a poor thermal conductivity hence it decreases the overall heat transfer coefficient apart from

restricting the flow. Therefore, for applications in freezers below 0°C , frequent defrosting of the evaporator is required.

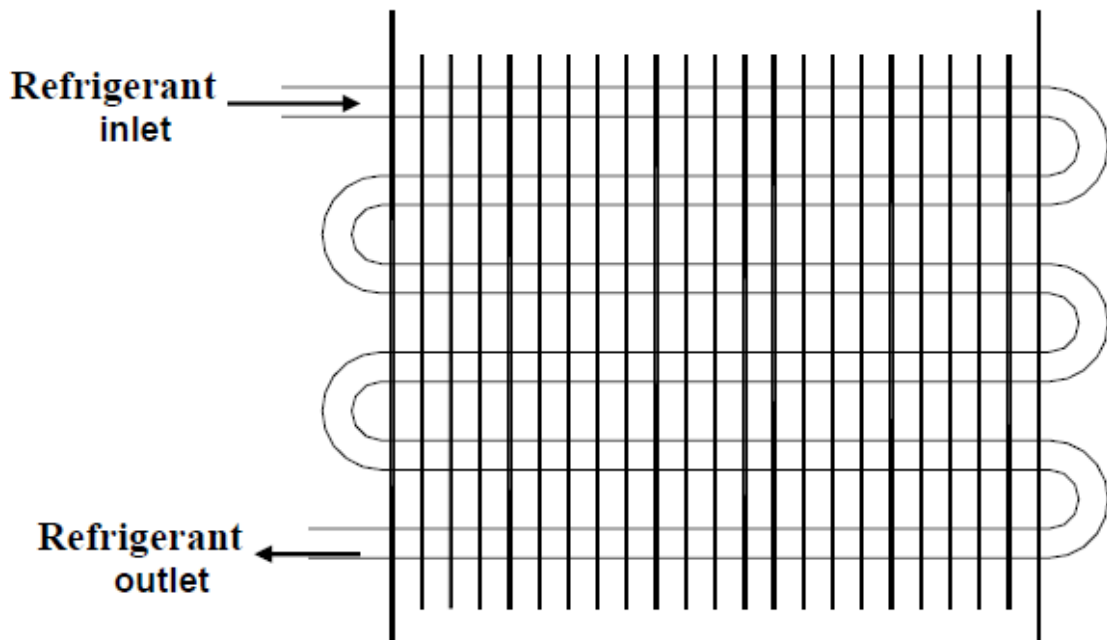

Plate Surface Evaporators

These are also called bonded plate or roll-bond type evaporators. Two flat sheets of metal (usually aluminum) are embossed in such a manner that when these are welded together, the embossed portion of the two plates makes a passage for refrigerant to flow. This type is used in household refrigerators. Figure shows the schematic of a roll-bond type evaporator. In another type of plate surface evaporator, a serpentine tube is placed between two metal plates such that plates press on to the tube. The edges of the plates are welded together. The space between the plates is either filled with a eutectic solution or evacuated. The vacuum between the plates and atmospheric pressure outside, presses the plates on to the refrigerant carrying tubes making a very good contact between them. If eutectic solution is filled into the void space, this also makes a good thermal contact between refrigerant carrying tubes and the plates. Further, it provides an additional thermal storage capacity during off-cycle and load shedding to maintain a uniform temperature. These evaporators are commonly used in refrigerated trucks. Figure shows an embedded tube, plate surface evaporator. A-A Section A-A Refrigerant in Refrigerant out Fig. Schematic of a roll-bond type evaporator.

Plate type Evaporators:

Plate type evaporators are used when a close temperature approach (0.5 K or less) between the boiling refrigerant and the fluid being chilled is required. These evaporators are widely used in dairy plants for chilling milk, in breweries for chilling beer. These evaporators consist of a series of plates (normally made of stainless steel) between which alternately the milk or beer to be cooled and refrigerant flow in counterflow direction. The overall heat transfer coefficient of these plate type evaporators is very high (as high as $4500\text{ W/m}^2\text{ K}$ in case of ammonia/water and $3000\text{ W/m}^2\text{ K}$ in case of R 22/water). In addition they also require very

less refrigerant inventory for the same capacity (about 10 percent or even less than that of shell-and-tube type evaporators). Another important advantage when used in dairy plants and breweries is that, it is very easy to clean the evaporator and assemble it back as and when required. The capacity can be increased or decreased very easily by adding or removing plates. Hence these evaporators are finding widespread use in a variety of applications. Figure shows the schematic of a plate type evaporator.

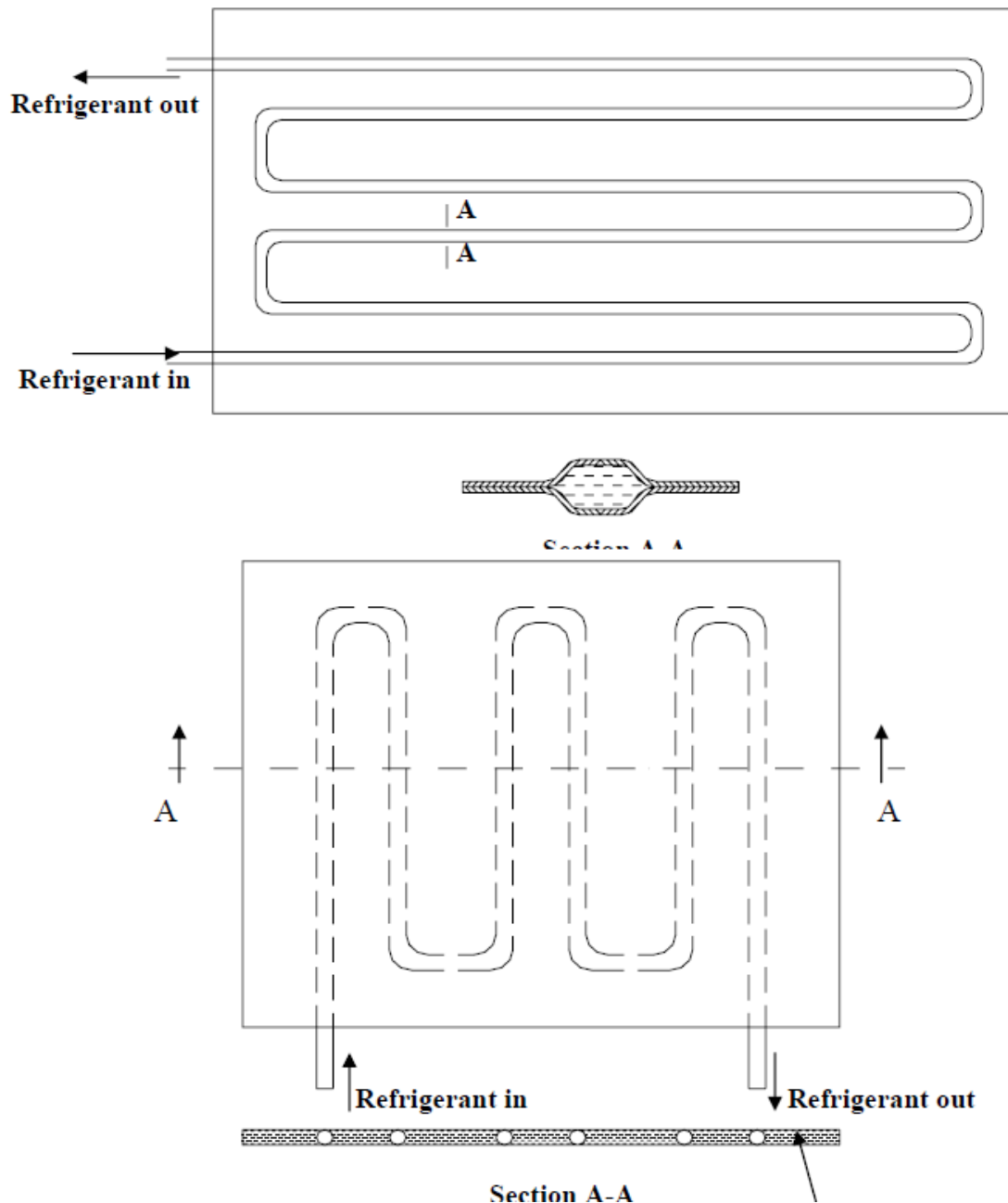

EXPANSION DEVICE

An expansion device is another basic component of a refrigeration system. The basic functions of an expansion device used in refrigeration systems are to:

1. Reduce pressure from condenser pressure to evaporator pressure, and

2. Regulate the refrigerant flow from the high-pressure liquid line into the evaporator at a rate equal to the evaporation rate in the evaporator

The expansion devices used in refrigeration systems can be divided into fixed opening type or variable opening type. As the name implies, in fixed opening type the flow area remains fixed, while in variable opening type the flow area changes with changing mass flow rates. There are basically seven types of refrigerant expansion devices. These are:

1. Hand (manual) expansion valves
2. Capillary Tubes
3. Orifice
4. Constant pressure or Automatic Expansion Valve (AEV)
5. Thermostatic Expansion Valve (TEV)
6. Float type Expansion Valve
 - a) High Side Float Valve
 - b) Low Side Float Valve
7. Electronic Expansion Valve

Of the above seven types, Capillary tube and orifice belong to the fixed opening type, while the rest belong to the variable opening type. Of the above seven types, the hand operated expansion valve is not used when an automatic control is required. The orifice type expansion is used only in some special applications.

Capillary Tube

A capillary tube is a long, narrow tube of constant diameter. The word “capillary” is a misnomer since surface tension is not important in refrigeration application of capillary tubes. Typical tube diameters of refrigerant capillary tubes range from 0.5 mm to 3 mm and the length ranges from 1.0 m to 6 m.

The pressure reduction in a capillary tube occurs due to the following two factors:

1. The refrigerant has to overcome the frictional resistance offered by tube walls. This leads to some pressure drop, and
2. The liquid refrigerant flashes (evaporates) into mixture of liquid and vapour as its pressure reduces. The density of vapour is less than that of the liquid. Hence, the average density of refrigerant decreases as it flows in the tube. The mass flow rate and tube diameter (hence area) being constant, the velocity of refrigerant increases since $m = \rho VA$. The increase in velocity or acceleration of the refrigerant also requires pressure drop. $m \propto$

Several combinations of length and bore are available for the same mass flow rate and pressure drop. However, once a capillary tube of some diameter and length has been installed in a refrigeration system, the mass flow rate through it will vary in such a manner that the total pressure drop through it matches with the pressure difference between condenser and the evaporator. Its mass flow rate is totally dependent upon the pressure difference across it; it cannot adjust itself to variation of load effectively.

Advantages and disadvantages of capillary tubes

Advantages of a capillary tube are:

1. It is inexpensive.
2. It does not have any moving parts hence it does not require maintenance
3. Capillary tube provides an open connection between condenser and the evaporator hence during off-cycle, pressure equalization occurs between condenser and evaporator. This reduces the starting torque requirement of the motor since the motor starts with same pressure on the two sides of the compressor. Hence, a motor with low starting torque (squirrel cage Induction motor) can be used.
4. Ideal for hermetic compressor based systems, which are critically charged and factory assembled.

Disadvantages of the capillary tube are:

1. It cannot adjust itself to changing flow conditions in response to daily and seasonal variation in ambient temperature and load. Hence, COP is usually low under off design conditions.
2. It is susceptible to clogging because of narrow bore of the tube, hence, utmost care is required at the time of assembly. A filter-drier should be used ahead of the capillary to prevent entry of moisture or any solid particles
3. During off-cycle liquid refrigerant flows to evaporator because of pressure difference between condenser and evaporator. The evaporator may get flooded and the liquid refrigerant may flow to compressor and damage it when it starts. Therefore critical charge is used in capillary tube based systems. Further, it is used only with hermetically sealed compressors where refrigerant does not leak so that critical charge can be used. Normally an accumulator is provided after the evaporator to prevent slugging of compressor

Automatic Expansion Valve (AEV)

An Automatic Expansion Valve (AEV) also known as a constant pressure expansion valve acts in such a manner so as to maintain a constant pressure and thereby a constant temperature in the evaporator. The schematic diagram of the valve is shown in Fig. As shown in the figure, the valve consists of an adjustment spring that can be adjusted to maintain the required temperature in the evaporator. This exerts force F_s on the top of the diaphragm. The atmospheric pressure, P_o also acts on top of the diaphragm and exerts a force of $F_o = P_o A_d$, A_d being the area of the diaphragm. The evaporator pressure P_e acts below the diaphragm. The force due to evaporator pressure is $F_e = P_e A_d$. The net downward force $F_s + F_o - F_e$ is fed to the needle by the diaphragm. This net $F_e + F_o > F_s + F_{fs}$ force along with the force due to follow-up spring F_{fs} controls the location of the needle with respect to the orifice and thereby controls the orifice opening.

If $F_e + F_{fs} > F_s + F_o$ the needle will be pushed against the orifice and the valve will be fully closed.

On the other hand if $F_e + F_{fs} < F_s + F_o$, the needle will be away from the orifice and the valve will be open. Hence the relative magnitude of these forces controls the mass flow rate through the expansion valve.

The adjustment spring is usually set such that during off-cycle the valve is closed, that is, the needle is pushed against the orifice. Hence,

$$F_{e0} + F_{fso} > F_{so} + F_o$$

Where, subscript o refers to forces during off cycle. During the off-cycle, the refrigerant remaining in the evaporator will vaporize but will not be taken out by the compressor, as a result the evaporator pressure rises during the off-cycle.

When the compressor is started after the off-cycle period, the evaporator pressure P_e starts decreasing at a very fast rate since valve is closed; refrigerant is not fed to evaporator while the compressor removes the refrigerant from the evaporator. As P_e decreases the force F_e decreases from F_{e0} to $(F_{e0} - \Delta F_e)$. At one stage, the sum $F_e + F_{fs}$ becomes less than $F_s + F_o$, as a result the needle stand moves downwards (away from the needle stand) and the valve opens. Under this condition,

$$(F_{e0} - \Delta F_e) + F_{fso} < F_{so} + F_o$$

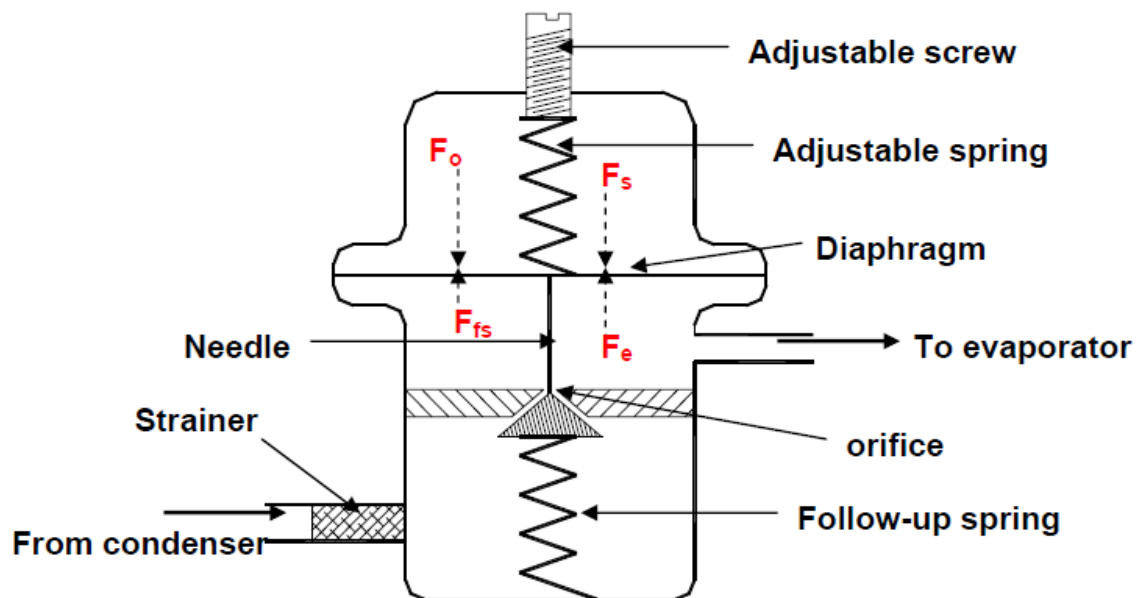

When the refrigerant starts to enter the evaporator, the evaporator pressure does not decrease at the same fast rate as at starting time. Thus, the movement of the needle stand will slow down as the refrigerant starts entering. As the needle moves downwards, the adjustment spring elongates, therefore the force F_s decreases from its off-cycle value of F_{s0} , the decrease being proportional to the movement of the needle.

As the needle moves downwards, the follow-up spring is compressed; as a result, F_{fs} increases from its off-cycle value. Hence, the final equation may be written as,

$$(F_{e0} - \Delta F_e) + (F_{fso} + \Delta F_{fs}) = (F_{so} - \Delta F_s) + F_o$$

or

$$F_e + F_{fs} = F_s + F_o = \text{constant}$$

The constant is sum of force due to spring force and the atmospheric pressure, hence it depends upon position of adjustment spring. This will be the equilibrium position. Then onwards, the valve acts in such a manner that the Time P_e evaporator pressure remains constant as long as the refrigeration load is constant. At this point, the mass flow rate through the valve is the same as that through the compressor.

Decrease In Load

If the refrigeration load decreases, there is a tendency in the evaporator for the evaporator temperature to decrease and thereby the evaporator pressure (saturation pressure) also decreases. This decreases the force F_e . The sum $F_e + F_{fs}$ will become less than the sum on right hand side of Equation and the needle stand will be pushed downwards opening the orifice wider. This will increase the mass flow rate through the valve. This is opposite of the requirement since at lower load, a lower mass flow rate of the refrigerant is required. This is the drawback of this valve that it counteracts in an opposite manner since it tries to keep the evaporator pressure at a constant value. The compressor capacity remains the same. The valve feeds more refrigerant to the evaporator than the compressor can remove from the evaporator. This causes accumulation of liquid refrigerant in the evaporator. This is called “flooding” of the evaporator. The liquid refrigerant may fill the evaporator and it may overflow to the compressor causing damage to it.

Increase In Load

On the other hand if the refrigeration load increases or the evaporator heat transfer rate increases, the evaporator temperature and pressure will increase for a flooded evaporator. This will increase F_e . This will tend to move the needle stand upwards, consequently making the orifice opening narrower and decreasing the mass flow rate. Again the valve counteracts in a manner opposite to what is required. The compressor draws out more refrigerant than that fed by the expansion valve leading to starving of the evaporator.

Applications of automatic expansion valve

The automatic expansion valves are used wherever constant temperature is required, for example, milk chilling units and water coolers where freezing is disastrous. In air-conditioning systems it is used when humidity control is by DX coil temperature. Automatic expansion valves are simple in design and are economical. These are also used in home freezers and small commercial refrigeration systems where hermetic compressors are used. Normally the usage is limited to systems of less than 10 TR capacities with critical charge. Critical charge has to be used since the system using AEV is prone to flooding. Hence, no receivers are used in these systems. In some valves a diaphragm is used in place of bellows.

Thermostatic Expansion Valve (TEV)

Thermostatic expansion valve is the most versatile expansion valve and is most commonly used in refrigeration systems. A thermostatic expansion valve maintains a constant degree of superheat at the exit of evaporator; hence it is most effective for dry evaporators in preventing the slugging of the compressors since it does not allow the liquid refrigerant to enter the compressor. The schematic diagram of the valve is given in Figure.

This consists of a feeler bulb that is attached to the evaporator exit tube so that it senses the temperature at the exit of evaporator. The feeler bulb is connected to the top of the bellows by a capillary tube. The feeler bulb and the narrow tube contain some fluid that is called power fluid. The power fluid may be the same as the refrigerant in the refrigeration system, or it may be different. In case it is different from the refrigerant, then the TEV is called TEV with cross charge. The pressure of the power fluid P_p is the saturation pressure corresponding to

the temperature at the evaporator exit. If the evaporator temperature is T_e and the corresponding saturation evaporator pressure is P_e , then the purpose of TEV is to maintain a temperature $T_e + \Delta T_s$ at the evaporator exit, where ΔT_s is the degree of superheat required from the TEV. The power fluid senses this temperature $T_e + \Delta T_s$ by the feeler bulb and its pressure P_p is the saturation pressure at this temperature. The force F_p exerted on top of bellows of area A_b due to this pressure is given by:

$$F_p = A_b P_p$$

The evaporator pressure is exerted below the bellows. In case the evaporator is large and has a significant pressure drop, the pressure from evaporator exit is fed directly to the bottom of the bellows by a narrow tube. This is called pressure-equalizing connection. Such a TEV is called TEV with external equalizer, otherwise it is known as TEV with internal equalizer. The force F_e exerted due to this pressure P_e on the bottom of the bellows is given by

$$F_e = A_b P_e$$

The difference of the two forces F_p and F_e is exerted on top of the needle stand. There is an adjustment spring below the needle stand that exerts an upward spring force F_s on the needle stand. In steady state there will be a force balance on the needle stand, that is,

$$F_s = F_p - F_e$$

During off-cycle, the evaporator temperature is same as room temperature throughout, that is, degree of superheat ΔT_s is zero. If the power fluid is the same as the refrigerant, then $P_p = P_e$ and $F_p = F_e$. Therefore any arbitrarily small spring force F_s acting upwards will push the needle stand against the orifice and keep the TEV closed. If it is TEV with cross charge or if there is a little degree of superheat during off-cycle then for TEV to remain closed during off-cycle, F_s should be slightly greater than $(F_p - F_e)$.

As the compressor is started, the evaporator pressure decreases at a very fast rate hence the force F_e decreases at a very fast rate. This happens since TEV is closed and no refrigerant is fed to evaporator while compressors draws out refrigerant at a very fast rate and tries to evacuate the evaporator. The force F_p does not change during this period since the evaporator temperature does not change. Hence, the difference $F_p - F_e$, increases as the compressor runs for some time after starting. At one point this difference becomes greater than the spring force F_s and pushes the needle stand downwards opening the orifice. The valve is said to open up. Since a finite downward force is required to open the valve, a minimum degree of superheat is required for a finite mass flow rate.

As the refrigerant enters the evaporator it arrests the fast rate of decrease of evaporator pressure. The movement of needle stand also slows down. The spring, however gets compressed as the needle stand moves downward to open the orifice. If F_{s0} is the spring force in the rest position, that is, off-cycle, then during open valve position

$$F_s = F_{s0} + \Delta F_s$$

Eventually, the needle stand reaches a position such that,

$$F_s = F_p - F_e = A_b (P_p - P_e)$$

That is, F_p is greater than F_e or P_p is greater than P_e . The pressure P_p and P_e are saturation pressures at temperature $(T_e + \Delta T_s)$ and T_e respectively. Hence, for a given setting force F_s of

the spring, TEV maintains the difference between F_p and F_e or the degree of superheat ΔT_s constant.

$$\Delta T_s \propto (F_p - F_e)$$

$$\propto F_s$$

This is irrespective of the level of P_e , that is, evaporator pressure or temperature, although degree of superheat may be slightly different at different evaporator temperatures for same spring force, F_s . It will be an ideal case if the degree of superheat is same at all evaporator temperatures for a given spring force.

Effect of Load Variation

If the load on the plant increases, the evaporation rate of liquid refrigerant increases, the area available for superheating the vapour increases. As the degree of superheat increases, pressure of power fluid P_p increases, the needle stand is pushed down and the mass flow rate of refrigerant increases. This is the ideal case. The evaporation rate of refrigerant is proportional to the load and the mass flow rate supplied through the expansion valve is also proportional to the load.

On the other hand, if the load on the plant decreases, the evaporation rate of refrigerant decreases, as a result the degree of superheat decreases. The thermostatic expansion valve reacts in such a way so as to reduce the mass flow rate through it. The flow rate of refrigerant in this valve is proportional to the evaporation rate of refrigerant in the evaporator. Hence, this valve always establishes balanced flow condition of flow between compressor and itself.

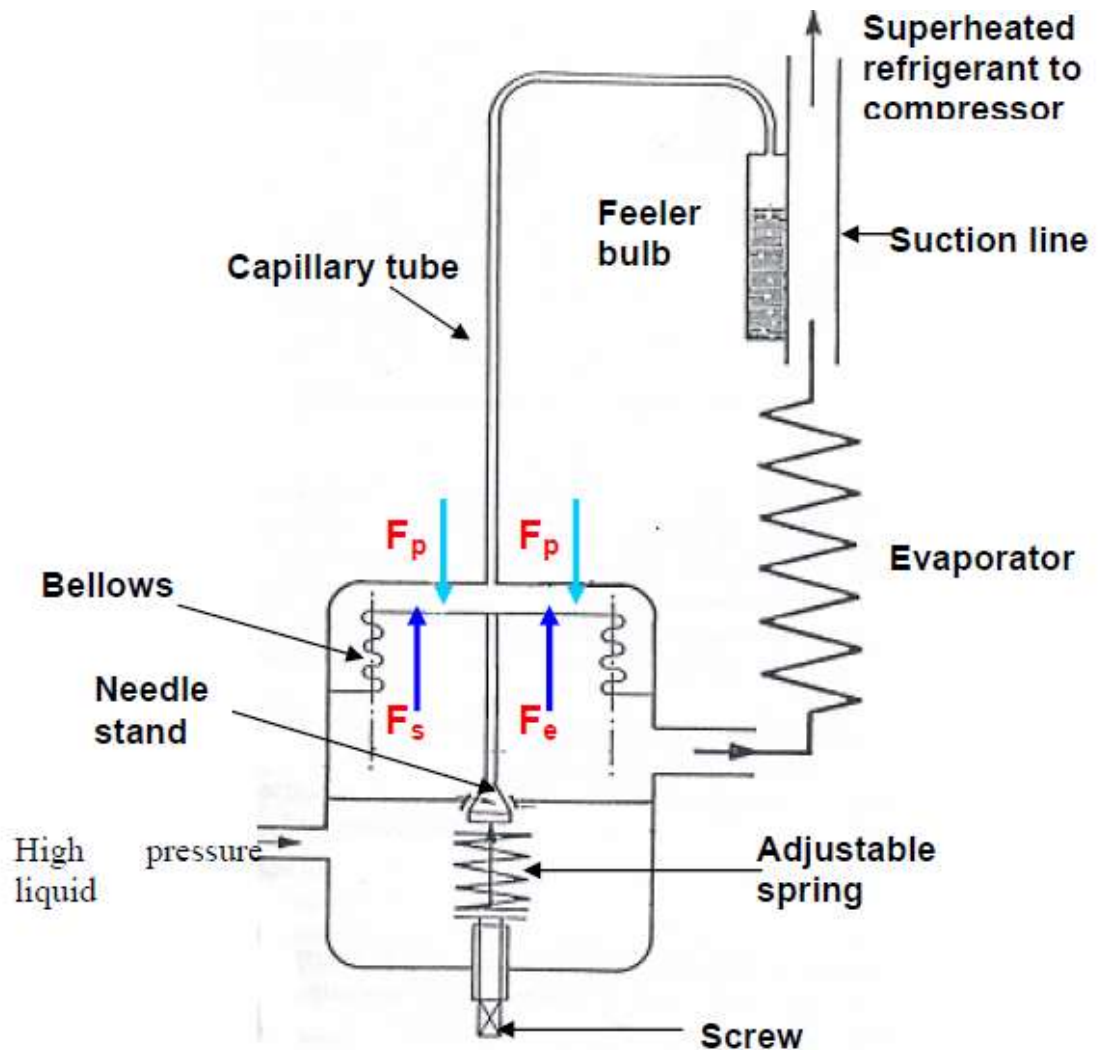

Advantages, disadvantages and applications of TEV

The advantages of TEV compared to other types of expansion devices are:

1. It provides excellent control of refrigeration capacity as the supply of refrigerant to the evaporator matches the demand
2. It ensures that the evaporator operates efficiently by preventing starving under high load conditions
3. It protects the compressor from slugging by ensuring a minimum degree of superheat under all conditions of load, if properly selected.

Disadvantages of TEV

1. Compared to capillary tubes and AEVs, a TEV is more expensive and proper precautions should be taken at the installation. For example, the feeler bulb must always be in good thermal contact with the refrigerant tube. The feeler bulb should preferably be insulated to reduce the influence of the ambient air. The bulb should be mounted such that the liquid is always in contact with the refrigerant tubing for proper control.
2. The use of TEV depends upon degree of superheat. Hence, in applications where a close approach between the fluid to be cooled and evaporator temperature is desired, TEV cannot be used since very small extent of superheating is available for operation. A counter flow arrangement can be used to achieve the desired superheat in such a

case. Alternately, a subcooling HEX may be used and the feeler bulb mounted on the vapour exit line of the HEX. The valves with bellows have longer stroke of the needle, which gives extra sensitivity compared to diaphragm type of valve. But valves with bellows are more expensive.

Applications:

Thermostatic Expansion Valves are normally selected from manufacturers' catalogs. The selection is based on the refrigeration capacity, type of the working fluid, operating temperature range etc. In practice, the design is different to suit different requirements such as single evaporators, multi-evaporators etc.

MODULE-3 VAPOUR ABSORPTION SYSTEM

Figure show a continuous output vapour compression refrigeration system and a continuous output vapour absorption refrigeration system. As shown in the figure in a continuous absorption system, low temperature and low pressure refrigerant with low quality enters the evaporator and vaporizes by producing useful refrigeration Q_e . From the evaporator, the low temperature, low pressure refrigerant vapour enters the absorber where it comes in contact with a solution that is weak in refrigerant. The weak solution absorbs the refrigerant and becomes strong in refrigerant. The heat of absorption is rejected to the external heat sink at T_o . The solution that is now rich in refrigerant is pumped to high pressure using a solution pump and fed to the generator. In the generator heat at high temperature T_g is supplied, as a result refrigerant vapour is generated at high pressure. This high pressure vapour is then condensed in the condenser by rejecting heat of condensation to the external heat sink at T_o .

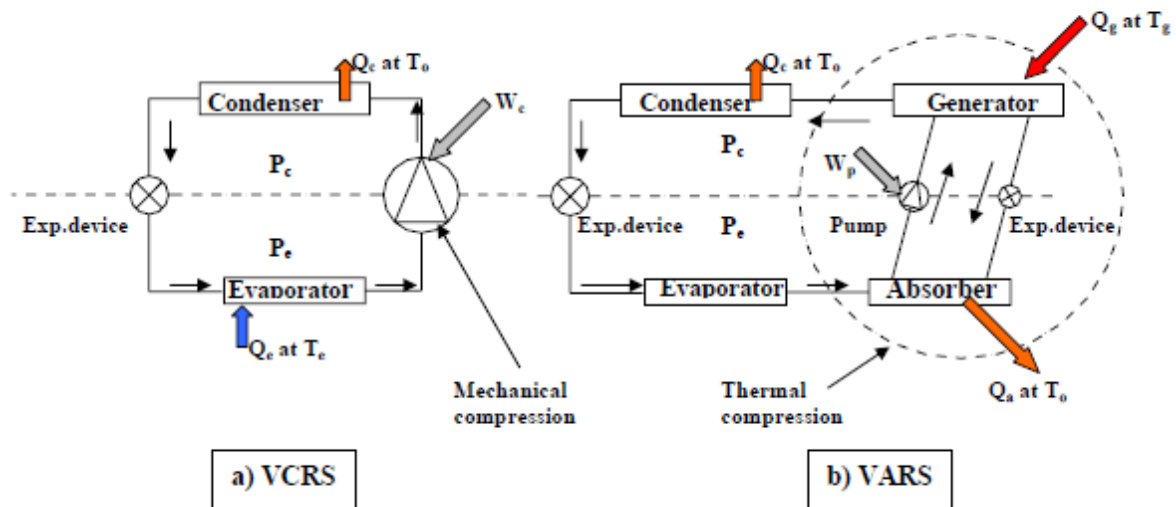

The condensed refrigerant liquid is then throttled in the expansion device and is then fed to the evaporator to complete the refrigerant cycle. On the solution side, the hot, high-pressure solution that is weak in refrigerant is throttled to the absorber pressure in the solution expansion valve and fed to the absorber where it comes in contact with the refrigerant vapour from evaporator. Thus continuous refrigeration is produced at evaporator, while heat at high temperature is continuously supplied to the generator. Heat rejection to the external heat sink takes place at absorber and condenser. A small amount of mechanical energy is required to run the solution pump. If we neglect pressure drops, then the absorption system operates between the condenser and evaporator pressures. Pressure in absorber is same as the pressure in evaporator and pressure in generator is same as the pressure in condenser.

It can be seen from Fig. that as far as the condenser, expansion valve and evaporators are concerned both compression and absorption systems are identical. However, the difference lies in the way the refrigerant is compressed to condenser pressure. In vapour compression refrigeration systems the vapour is compressed mechanically using the compressor, where as in absorption system the vapour is first converted into a liquid and then the liquid is pumped to condenser pressure using the solution pump. Since for the same pressure difference, work input required to pump a liquid (solution) is much less than the work required for compressing a vapour due to very small specific volume of liquid (), the mechanical energy required to

operate vapour absorption refrigeration system is much less than that required to operate a compression system. However, the absorption system requires a relatively large amount of low-grade thermal energy at generator temperature to generate refrigerant vapour from the solution in generator. Thus while the energy input is in the form of mechanical energy in vapour compression refrigeration systems, it is mainly in the form of thermal energy in case of absorption systems. The solution pump work is often negligible compared to the generator heat input. Thus the COPs for compression and absorption systems are given by:

$$\text{COP}_{\text{VCRS}} = \frac{Q_e}{W_c}$$

$$\text{COP}_{\text{VARS}} = \frac{Q_e}{Q_g + W_p} \approx \frac{Q_e}{Q_g}$$

Thus absorption systems are advantageous where a large quantity of low-grade thermal energy is available freely at required temperature. However, it will be seen that for the refrigeration and heat rejection temperatures, the COP of vapour compression refrigeration system will be much higher than the COP of an absorption system as a high grade mechanical energy is used in the former, while a low-grade thermal energy is used in the latter.

Maximum COP of ideal absorption refrigeration system

In case of a single stage compression refrigeration system operating between constant evaporator and condenser temperatures, the maximum possible COP is given by Carnot COP:

$$\text{COP}_{\text{Carnot}} = \frac{T_e}{T_c - T_e}$$

If we assume that heat rejection at the absorber and condenser takes place at same external heat sink temperature T_o , then a vapour absorption refrigeration system operates between three temperature levels, T_g , T_o and T_e . The maximum possible COP of a refrigeration system operating between three temperature levels can be obtained by Applying first and second laws of thermodynamics to the system. Figure shows the various energy transfers and the corresponding temperatures in an absorption refrigeration system.

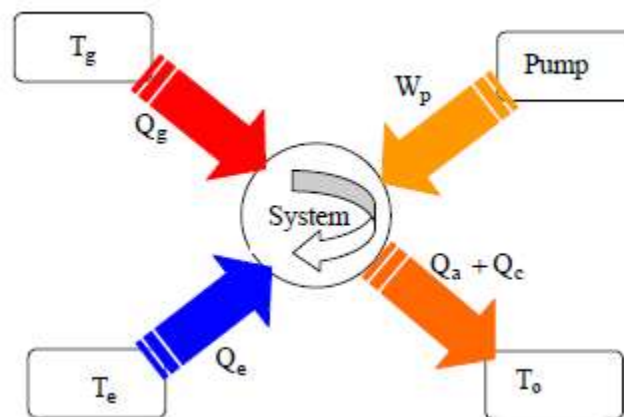

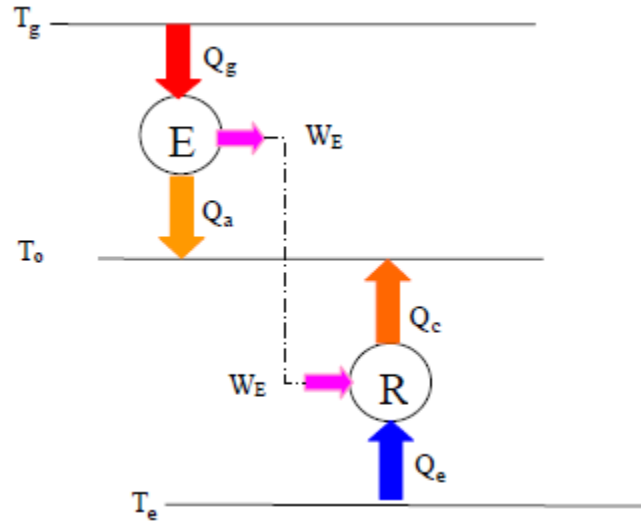

From first law of thermodynamics,

$$Q_e + Q_g - Q_{a+c} + W_p = 0$$

where Q_e is the heat transferred to the absorption system at evaporator temperature T_e , Q_g is the heat transferred to the generator of the absorption system at temperature T_g , Q_{a+c} is the heat transferred from the absorber and condenser of the absorption system at temperature T_o and W_p is the work input to the solution pump.

From second law of thermodynamics,

$$\Delta S_{\text{total}} = \Delta S_{\text{sys}} + \Delta S_{\text{surr}} \geq 0$$

where ΔS_{total} is the total entropy change which is equal to the sum of entropy change of the system ΔS_{sys} and entropy change of the surroundings ΔS_{surr} . Since the refrigeration system operates in a closed cycle, the entropy change of the working fluid of the system undergoing the cycle is zero, i.e., $\Delta S_{\text{sys}} = 0$. The entropy change of the surroundings is given by:

$$\Delta S_{\text{surr}} = -\frac{Q_e}{T_e} - \frac{Q_g}{T_g} + \frac{Q_{a+c}}{T_o} \geq 0$$

Substituting the expression for first law of thermodynamics in the above equation

$$Q_g \left(\frac{T_g - T_o}{T_g} \right) \geq Q_e \left(\frac{T_o - T_e}{T_e} \right) - W_p$$

Neglecting solution pump work, W_p ; the COP of VARS is given by:

$$\text{COP}_{\text{VARS}} = \frac{Q_e}{Q_g} \leq \left(\frac{T_e}{T_o - T_e} \right) \left(\frac{T_g - T_o}{T_g} \right)$$

An ideal vapour absorption refrigeration system is totally reversible (i.e., both internally and externally reversible). For a completely reversible system the total entropy change (system+surroundings) is zero according to second law, hence for an ideal VARS

$$\Delta S_{\text{total,rev}} = 0 \Rightarrow \Delta S_{\text{surr,rev}} = 0.$$

Hence:

$$\Delta S_{\text{surr,rev}} = -\frac{Q_e}{T_e} - \frac{Q_g}{T_g} + \frac{Q_{a+c}}{T_o} = 0$$

Hence combining first and second laws and neglecting pump work, the maximum possible COP of an ideal VARS system is given by:

$$\text{COP}_{\text{ideal VARS}} = \frac{Q_e}{Q_g} = \left(\frac{T_e}{T_o - T_e} \right) \left(\frac{T_g - T_o}{T_g} \right)$$

Thus the ideal COP is only a function of operating temperatures similar to Carnot system. It can be seen from the above expression that the ideal COP of VARS system is equal to the product of efficiency of a Carnot heat engine operating between T_g and T_o and COP of a Carnot refrigeration system operating between T_o and T_e , i.e.,

$$\text{COP}_{\text{ideal VARS}} = \frac{Q_e}{Q_g} = \left(\frac{T_e}{T_o - T_e} \right) \left(\frac{T_g - T_o}{T_g} \right) = \text{COP}_{\text{Carnot}} \cdot \eta_{\text{Carnot}}$$

Thus an ideal vapour absorption refrigeration system can be considered to be a combined system consisting of a Carnot heat engine and a Carnot refrigerator as shown in Fig.. Thus the COP of an ideal VARS increases as generator temperature (T_g) and evaporator temperature (T_e) increase and heat rejection temperature (T_o) decreases. However, the COP of actual VARS will be much less than that of an ideal VARS due to various internal and external irreversibilities present in actual systems.

Refrigerant-absorbent combinations for VARS

The desirable properties of refrigerant-absorbent mixtures for VARS are:

- i. The refrigerant should exhibit high solubility with solution in the absorber. This is to say that it should exhibit negative deviation from Raoult's law at absorber.
- ii. There should be large difference in the boiling points of refrigerant and absorbent (greater than 200 °C), so that only refrigerant is boiled-off in the generator. This ensures that only pure refrigerant circulates through refrigerant circuit (condenser-expansion valve-evaporator) leading to isothermal heat transfer in evaporator and condenser.
- iii. It should exhibit small heat of mixing so that a high COP can be achieved. However, this requirement contradicts the first requirement. Hence, in practice a trade-off is required between solubility and heat of mixing.
- iv. The refrigerant-absorbent mixture should have high thermal conductivity and low viscosity for high performance.
- v. It should not undergo crystallization or solidification inside the system.
- vi. The mixture should be safe, chemically stable, non-corrosive, inexpensive and should be available easily.

The most commonly used refrigerant-absorbent pairs in commercial systems are:

1. Water-Lithium Bromide ($\text{H}_2\text{O-LiBr}$) system for above 0°C applications such as air conditioning. Here water is the refrigerant and lithium bromide is the absorbent.
2. Ammonia-Water ($\text{NH}_3\text{-H}_2\text{O}$) system for refrigeration applications with ammonia as refrigerant and water as absorbent.

Of late efforts are being made to develop other refrigerant-absorbent systems using both natural and synthetic refrigerants to overcome some of the limitations of ($\text{H}_2\text{O-LiBr}$) and ($\text{NH}_3\text{-H}_2\text{O}$) systems.

Currently, large water-lithium bromide ($\text{H}_2\text{O-LiBr}$) systems are extensively used in air conditioning applications, where as large ammonia-water ($\text{NH}_3\text{-H}_2\text{O}$) systems are used in refrigeration applications, while small ammonia-water systems with a third inert gas are used in a pumpless form in small domestic refrigerators (triple fluid vapour absorption systems).

Ammonia-water VARS

Vapour absorption refrigeration system based on ammonia-water is one of the oldest refrigeration systems. In this system ammonia is used as refrigerant and water is used as absorbent. Since the boiling point temperature difference between ammonia and water is not very high, both ammonia and water are generated from the solution in the generator. Since presence of large amount of water in refrigerant circuit is detrimental to system performance, rectification of the generated vapour is carried out using a rectification column and a dephlegmator. Since ammonia is used as the refrigerant, these systems can be used for both refrigeration and air conditioning applications. They are available in very small (as pumpless systems) to large refrigeration capacities in applications ranging from domestic refrigerators to large cold storages. Since ammonia is not compatible with materials such as copper or brass, normally the entire system is fabricated out of steel. Another important difference between this system and water-lithium bromide systems is in the operating pressures. While water-lithium bromide systems operate under very low (high vacuum) pressures, the ammonia-water system is operated at pressures much higher than atmospheric. As a result, problem of air leakage into the system is eliminated. Also this system does not suffer from the problem of crystallization encountered in water-lithium bromide systems. However, unlike water, ammonia is both toxic and flammable. Hence, these systems need safety precautions.

Working principle

Figure shows the schematic of an ammonia-water absorption refrigeration system. Compared to water-lithium bromide systems, this system uses three additional components: **a rectification column, a dephlegmator and a subcooling heat exchanger** (Heat Exchanger-I). The function of rectification column and dephlegmator is to reduce the concentration of water vapour at the exit of the generator. Without these the vapour leaving the generator may consist of **five to ten percent of water**. However, with rectification column and dephlegmator the concentration of water is **reduced to less than one percent**. The rectification column could be in the form of a packed bed or a spray column or a perforated plate column in which the vapour and solution exchange heat and mass. It is designed to provide a large residence time for the

fluids so that high heat and mass transfer rates could be obtained. The subcooling heat exchanger, which is normally of counterflow type is used to increase the refrigeration effect and to ensure liquid entry into the refrigerant expansion valve.

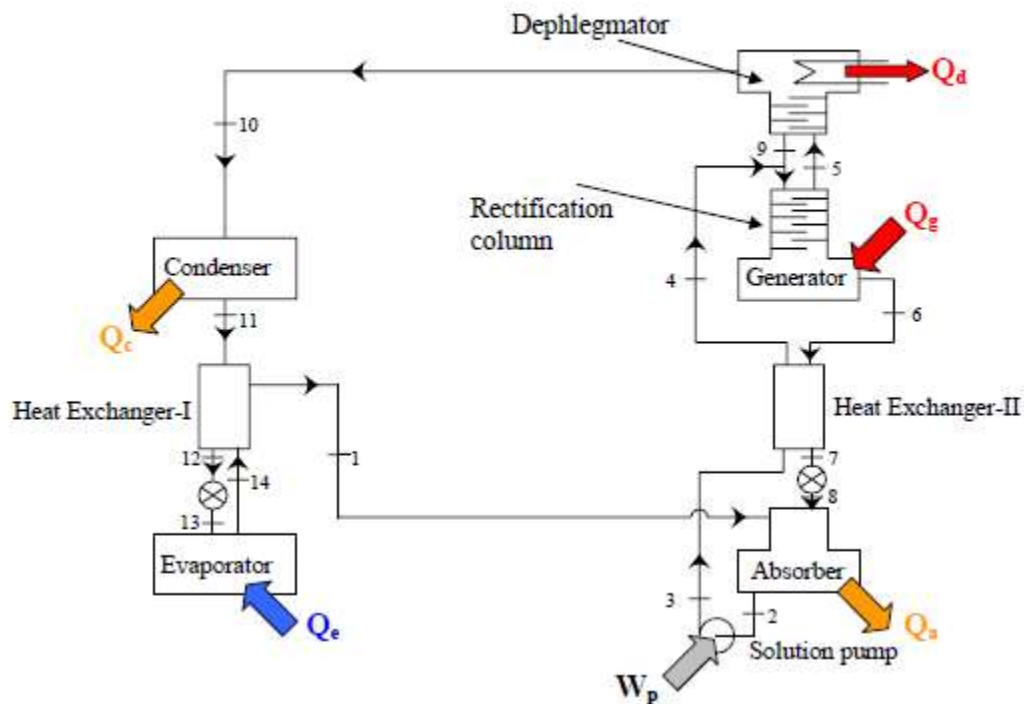

As shown in the figure, low temperature and low pressure vapour (almost pure ammonia) at state 14 leaves the evaporator, exchanges heat with the condensed liquid in Heat Exchanger-I and enters the absorber at state 1. This refrigerant is absorbed by the weak solution (weak in ammonia) coming from the solution expansion valve, state 8. The heat of absorption, Q_a is rejected to an external heat sink.

Next the strong solution that is now rich in ammonia leaves the absorber at state 2 and is pumped by the solution pump to generator pressure, state 3. This high pressure solution is then pre-heated in the solution heat exchanger to an external heat sink. The condensed liquid at state 11 is subcooled to state 12 in the subcooling heat exchanger by rejecting heat to the low temperature, low pressure vapour coming from the evaporator. The subcooled, high pressure liquid is then throttled in the refrigerant expansion valve to state 13.

The low temperature, low pressure and low quality refrigerant then enters the evaporator, extracts heat from the refrigerated space (Q) and leaves the evaporator at state 14. From here it enters the subcooling heat exchanger to complete the refrigerant cycle. Now, the condensed water in the dephlegmator at state 9 flows down into the rectifying column along with rich solution and exchanges heat and mass with the vapour moving upwards.

The hot solution that is now weak in refrigerant at state 6 flows into the solution heat exchanger where it is cooled to state 7 by preheating the rich solution. The weak, but high pressure solution at state 7 is then throttled in the solution expansion valve to state 8, from where it enters the absorber to complete its cycle. (Heat Exchanger-II) to state 4. The preheated solution at state 4 enters the generator and exchanges heat and mass with the hot vapour flowing out of the generator in the rectification column. In the generator, heat is supplied to the solution (Q_g).

As a result vapour of ammonia and water are generated in the generator. As mentioned, this hot vapour with five to ten percent of water exchanges heat and mass with the rich solution descending from the top. During this process, the temperature of the vapour and its water content are reduced. This vapour at state 5 then enters the dephlegmator, where most of the water vapour in the mixture is removed by cooling and condensation. Since this process is exothermic, heat (Q_d) is rejected to an external heat sink in the dephlegmator. The resulting vapour at state 10, which is almost pure ammonia (mass fraction greater than 99 percent) then enters the condenser and is condensed by rejecting heat of condensation, $Q_{c e}$

As far as various energy flows out of the system are concerned, heat is supplied to the system at generator and evaporator, heat rejection takes place at absorber, condenser and dephlegmator and a small amount of work is supplied to the solution pump.

Principle of rectification column and dephlegmator

Figure shows the schematic of the rectification system consisting of the generator, rectifying column and dephlegmator. As shown in the figure, strong solution from absorber enters at the rectification column, vapour rich in ammonia leaves at the top of the dephlegmator and weak solution leaves from the bottom of the generator. A heating medium supplies the required heat input Q_g to the generator and heat Q_d is rejected to the cooling water in the dephlegmator.

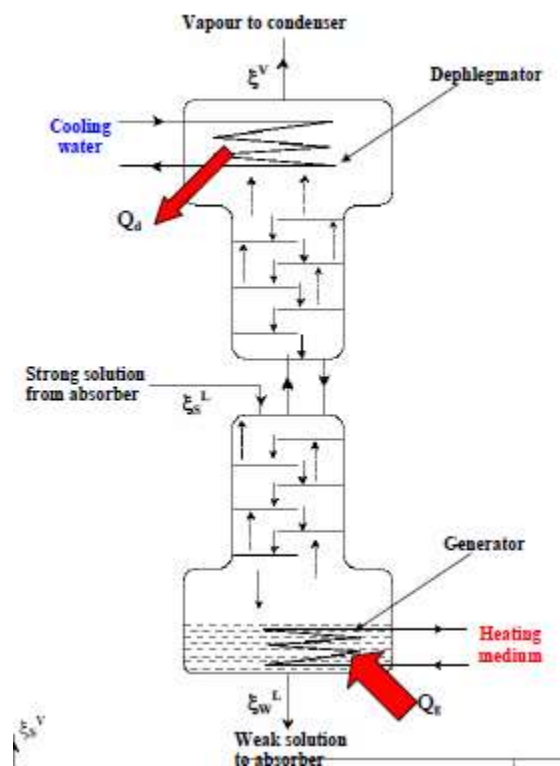

Figure shows the schematic of the generator with lower portion of the rectification column and the process that takes place in this column on temperature-composition diagram. As shown, in this column the ascending vapour generated in the generator and initially at a mass fraction enriched in ammonia as it exchanges heat and mass with the descending rich solution, which had an initial concentration. During this process the solution becomes weak as ammonia is transferred from liquid to vapour and water is transferred from vapour to liquid. In the limit with infinite residence time, the vapour leaves at mass fraction that is in equilibrium with the strong solution. It can also be seen that during this process, due to heat transfer from the hot vapour to the liquid, the solution entering the generator section is preheated. This is beneficial as it reduces the required heat input in the generator.

Figure shows the principle of dephlegmator (or reflux condenser) in which the ascending vapour is further enriched. At the top of the dephlegmator, heat is removed from the vapour so that a part of the vapour condenses (reflux). This reflux that is cooler, exchanges heat with the hotter vapour ascending in the column. During this process water vapour is transferred from the vapour to the liquid and ammonia is transferred from liquid to the vapour as shown in Fig. As a result the vapour leaves the rectification column in almost pure ammonia form with a concentration .

Pumpless vapour absorption refrigeration systems

Conventional absorption refrigeration systems use a mechanical pump for pumping the solution from absorber pressure to generator pressure. However, there are also absorption refrigeration systems that do not require a mechanical pump. These systems offer several advantages over conventional systems such as:

- i. High reliability due to absence of moving parts
- ii. Very little maintenance
- iii. Systems require only low grade thermal energy, hence no need for any grid power
- iv. Silent operation

Due to the above advantages the pumpless systems find applications such as refrigerators for remote and rural areas, portable refrigerators, refrigerators for luxury hotel rooms etc.

Several pumpless systems using both water-lithium bromide and ammonia-water have been developed over the last many decades. However, among these the most popular and widely used system is the one known as Platen-Munters system or Triple Fluid Vapour Absorption Refrigeration System (TFVARS). This system was developed by Platen and Munters of Sweden in 1930s. It uses ammonia as refrigerant and water as absorbent and hydrogen as an inert gas. Unlike conventional systems, the total pressure is constant throughout the Platen-Munters system, thus eliminating the need for mechanical pump or compressor. To allow the refrigerant (ammonia) **to evaporate at low temperatures in the evaporator**, a third inert gas (hydrogen) is introduced into the evaporator-absorber of the system. Thus even though the total pressure is constant throughout

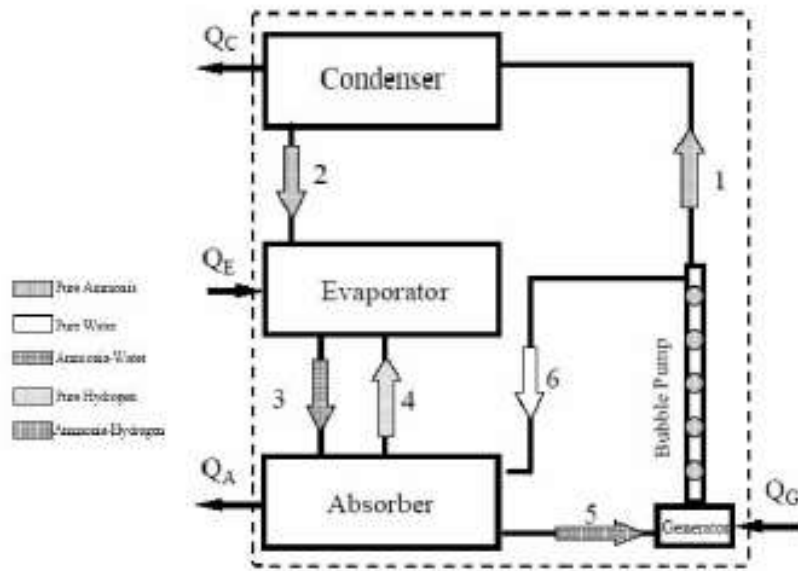

the system, the partial pressure of ammonia in evaporator is much smaller than the total pressure due to the presence of hydrogen.

For example: if the total pressure of the system is 15 bar, then the condenser temperature will be 38.7°C (saturation temperature at 15 bar). If contribution of hydrogen to total pressure in the evaporator is 14 bar, then the partial pressure of ammonia in evaporator is 1 bar, hence ammonia can evaporate at -33°C (saturation temperature at 1 bar), thus providing refrigeration effect at very low temperatures.

The liquid **ammonia in the evaporator cannot boil in the evaporator as its partial pressure is lower than the total pressure** (no vapour bubbles form). The **ammonia simply evaporates** into the hydrogen gas (just as liquid water evaporates into the atmosphere) as long as hydrogen process of diffusion, hence Platen-Munters systems are also called as **diffusion-absorption** gas is not

saturated with ammonia. The ammonia vapour generated is carried away by the **systems**.

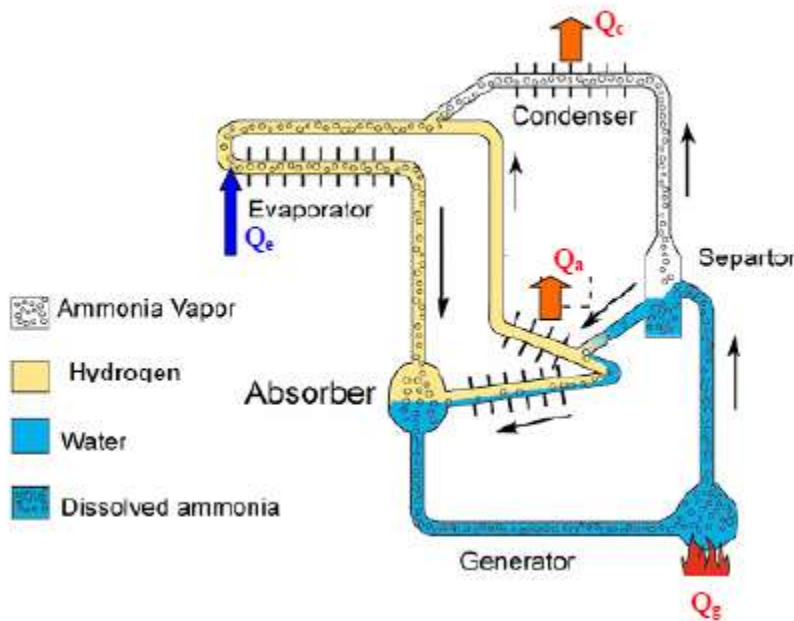

Figure shows the schematic of a triple-fluid Platen-Munters system. Starting with the strong solution at the exit of the absorber (state 5), heat is supplied in the generator; ammonia vapour is generated as a result. The vapour generated moves up through the bubble pump due to buoyancy. As the vapour moves up it carries the weak solution to the top of the bubble pump. At the top, the weak solution and vapour are separated. The refrigerant vapour at state 1 flows into the condenser, where it condenses by rejecting heat to the heat sink (condensation takes place at high temperature as ammonia pressure is equal to the total pressure). The condensed liquid at state 2 flows into evaporator. As it enters into the evaporator its pressure is reduced to its partial pressure at evaporator temperature due to the presence of hydrogen gas in the evaporator. Due to the reduction in pressure, the ammonia evaporates by taking heat from the refrigerated space. The ammonia vapour diffuses into the hydrogen gas. Since the mixture of ammonia and hydrogen are cooler, it flows down into the absorber due to buoyancy. In the absorber, the ammonia vapour is absorbed by the weak solution coming from the bubble pump. Heat of absorption is rejected to the heat sink. Due to this, the temperature of hydrogen gas increases and it flows back into the evaporator due to buoyancy. Thus the circulation of fluids throughout the system is maintained due to buoyancy effects and gravity.

Due to the evaporation process (as against boiling in conventional systems) the temperature of the evaporating liquid changes along the length of the evaporator. **The coldest part is obtained at the end where hydrogen enters the evaporator as the partial of ammonia is least at this portion.** This effect can be used to provide two temperature sections in the evaporator for example: one for frozen food storage and the other for fresh food storage etc.

A **liquid seal** is required at the end of the condenser to prevent the entry of hydrogen gas into the condenser. Commercial Platen-Munters systems are made of all steel with welded joints. Additives are added to minimize corrosion and rust formation and also to improve absorption. Since there

are no flared joints and if the quality of the welding is good, then these systems become extremely rugged and reliable. The Platen-Munters systems offer low COPs (of the order of 0.2) due to energy requirement in the bubble pump and also due to losses in the evaporator because of the presence of hydrogen gas. In addition, since the circulation of fluids inside the system is due to buoyancy and gravity, the heat and mass transfer coefficients are relatively small, further reducing the efficiency. However, these systems are available with a wide variety of heat sources such as electrical heaters (in small hotel room systems), natural gas or LPG gas, hot oils etc. Figure shows the schematic of the refrigeration system of a small commercial Platen-Munters system.

It is interesting to know that Albert Einstein along with Leo Szilard had obtained a US patent for a pumpless absorption refrigeration system in 1930. The principle of operation of this system is entirely different from that of Platen-Munters system. In Einstein's system, butane is used as the refrigerant, while ammonia is used as pressure equalizing fluid in evaporator. Water is used as the absorbent for the pressure equalizing fluid. However, unlike Platen-Munter's system, Einstein's system has not been commercialized. Recently attempts have been made to revive Einstein's cycle.

Water-lithium bromide

Vapour absorption refrigeration systems using water-lithium bromide pair are extensively used in large capacity air conditioning systems. In these systems water is used as refrigerant and a solution of lithium bromide in water is used as absorbent. Since water is used as refrigerant, using these systems it is not possible to provide refrigeration at sub-zero temperatures. Hence it is used only in applications requiring refrigeration at temperatures above 0°C . Hence these systems are used for air conditioning applications. The analysis of this system is relatively easy as the vapour generated in the generator is almost pure refrigerant (water), unlike ammonia-water systems where both ammonia and water vapour are generated in the generator.

Commercial systems

Commercial water-lithium bromide systems can be:

1. Single stage or single-effect systems, and

Single stage systems operate under two pressures – one corresponding to the condenser-generator (high pressure side) and the other corresponding to evaporator-absorber. Single stage systems can be

1. Two shell type
2. Four shell type

Since evaporator and absorber operate at the same pressure they can be housed in a single vessel, similarly generator and condenser can be placed in another vessel as these two components operate under a single pressure. Thus a two shell system consists of two vessels operating at high and low pressures. Figure shows a commercial, single stage, two shell system.

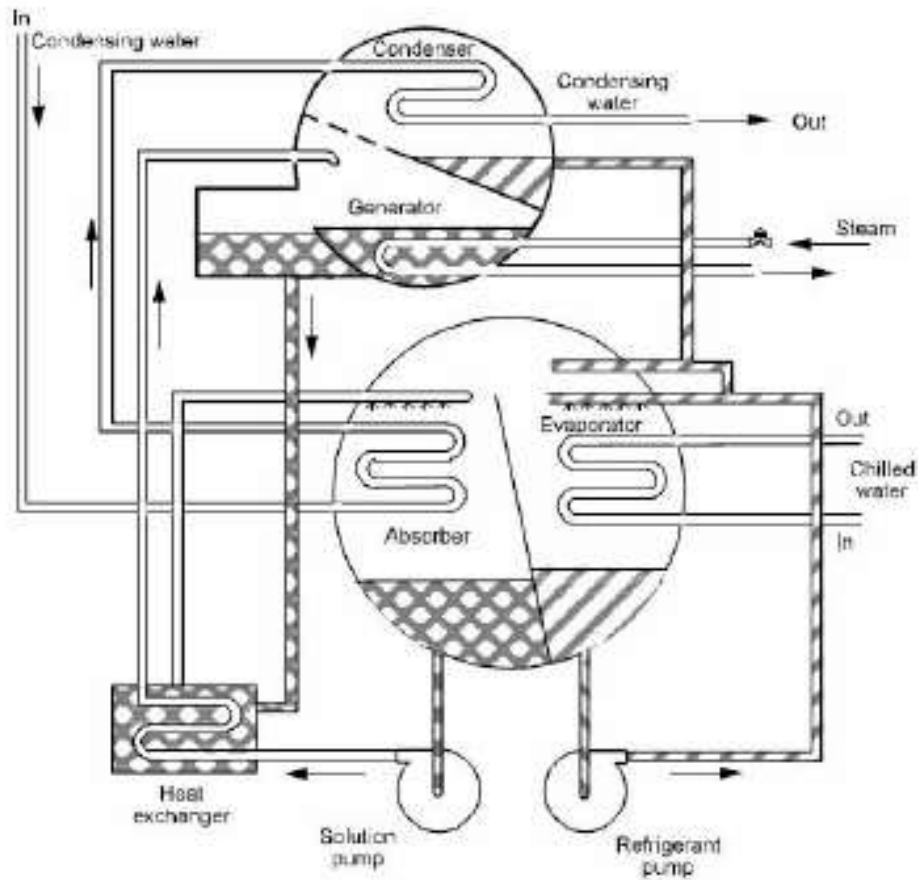

As shown in the figure, the cooling water (which acts as heat sink) flows first to absorber, extracts heat from absorber and then flows to the condenser for condenser heat extraction. This is known as series arrangement. This arrangement is advantageous as the required cooling water flow rate will be small and also by sending the cooling water first to the absorber, the condenser can be operated at a higher pressure to prevent crystallization. It is also possible to have cooling water flowing parallelly to condenser and absorber, however, the cooling water requirement in this case will be high. A refrigerant pump circulates liquid water in evaporator and the water is sprayed onto evaporator tubes for good heat and mass transfer. Heater tubes (steam or hot water or hot oil) are immersed in the strong solution pool of generator for vapour generation. Pressure drops between evaporator and absorber and between generator and condenser are minimized, large sized vapour lines are eliminated and air leakages can also be reduced due to less number of joints.

Comparison between compression and absorption refrigeration systems

Compression systems	Absorption systems
Work operated	Heat operated
High COP	Low COP (currently maximum ≈ 1.4)
Performance (COP and capacity) very sensitive to evaporator temperatures	Performance not very sensitive to evaporator temperatures
System COP reduces considerably at part loads	COP does not reduce significantly with load
Liquid at the exit of evaporator may damage compressor	Presence of liquid at evaporator exit is not a serious problem
Performance is sensitive to evaporator superheat	Evaporator superheat is not very important
Many moving parts	Very few moving parts
Regular maintenance required	Very low maintenance required
Higher noise and vibration	Less noise and vibration
Small systems are compact and large systems are bulky	Small systems are bulky and large systems are compact
Economical when electricity is available	Economical where low-cost fuels or waste heat is available

Steam Jet Refrigeration System:

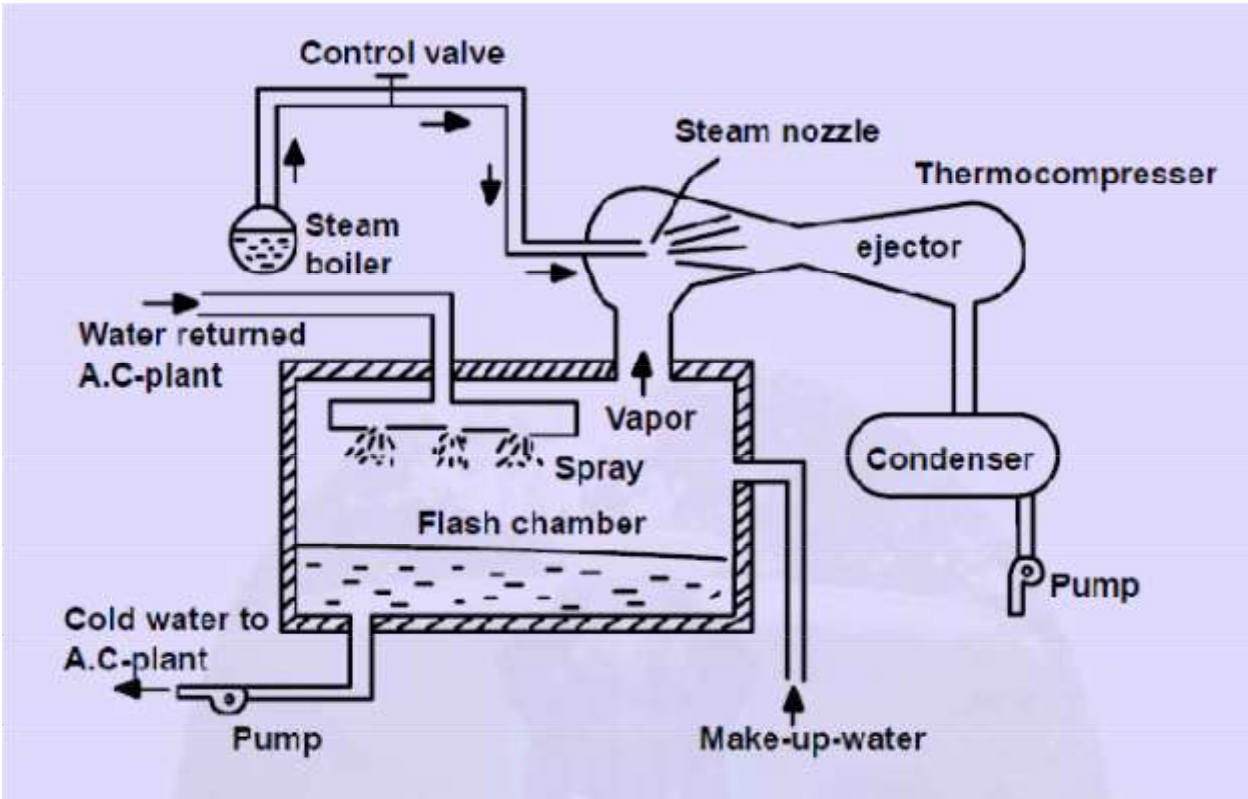

This system uses the principle of boiling the water below 100 C. If the pressure on the surface of the water is reduced below atmospheric pressure, water can be made boil at low temperatures. Water boils at 6 C, when the pressure on the surface is 5 cm of Hg and at 10 C, when the pressure is 6.5 cms of Hg. The very low pressure or high vacuum on the surface of the water can be maintained by throttling the steam through jets or nozzles. The general arrangement of the system is shown in the Fig

Operation:

High pressure steam is supplied to the nozzle from the boiler and it is expanded. Here, the water vapor originated from the flash chamber is entrained with the high velocity steam jet and it is further compressed in the thermo compressor. The kinetic energy of the mixture is converted into static pressure and mass is discharged to the condenser. The condensate is usually returned to the boiler. Generally, 1% evaporation of water in the flash chamber is sufficient to decrease the temperature of chilled water to 6 C. The chilled water in the flash chamber is circulated by a pump to the point of application. The warm water from the load is returned to the flash chamber. The water is sprayed through the nozzles to provide maximum surface area for cooling. The water, which is splashed in the chamber and any loss of cold water at the application, must be replaced by makeup water added to the cold water circulating system.

Advantages:

- a) *It is flexible in operation; cooling capacity can be easily and quickly changed.*
- b) *It has no moving parts as such it is vibration free.*
- c) *It can be installed out of doors.*
- d) *The weight of the system per ton of refrigerating capacity is less.*
- e) *The system is very reliable and maintenance cost is less.*
- f) *The system is particularly adapted to the processing of cold water used in rubber mills,, distilleries, paper mills, food processing plants, etc.*
- g) *This system is particularly used in air-conditioning installations, because of the complete safety of water as refrigerant and ability to adjust quickly to load variations and no hazard from the leakage of the refrigerant.*

Disadvantages:

- a) *The use of direct evaporation to produce chilled water is usually limited as tremendous volume of vapor is to be handled.*

b) About twice as much heat must be removed in the condenser of steam jet per ton of refrigeration compared with the vapor compression system.

c) The system is useful for comfort air-conditioning, but it is not practically feasible for water temperature below 4 C.

Vortex Tube (Non-Conventional):

It is one of the non-conventional type refrigerating systems for the production of refrigeration. The schematic diagram of vortex tube is shown in the Fig. It consists of nozzle, diaphragm, valve, hot-air side, cold-air side. The nozzles are of converging or diverging or converging-diverging type as per the design. An efficient nozzle is designed to have higher velocity, greater mass flow and minimum inlet losses. Chamber is a portion of nozzle and facilitates the tangential entry of high velocity air-stream into hot side. Generally the chambers are not of circular form, but they are gradually converted into spiral form. Hot side is cylindrical in cross section and is of different lengths as per design. Valve obstructs the flow of air through hot side and it also controls the quantity of hot air through vortex tube. Diaphragm is a cylindrical piece of small thickness and having a small hole of specific diameter at the center. Air stream traveling through the core of the hot side is emitted through the diaphragm hole. Cold side is a cylindrical portion through which cold air is passed.

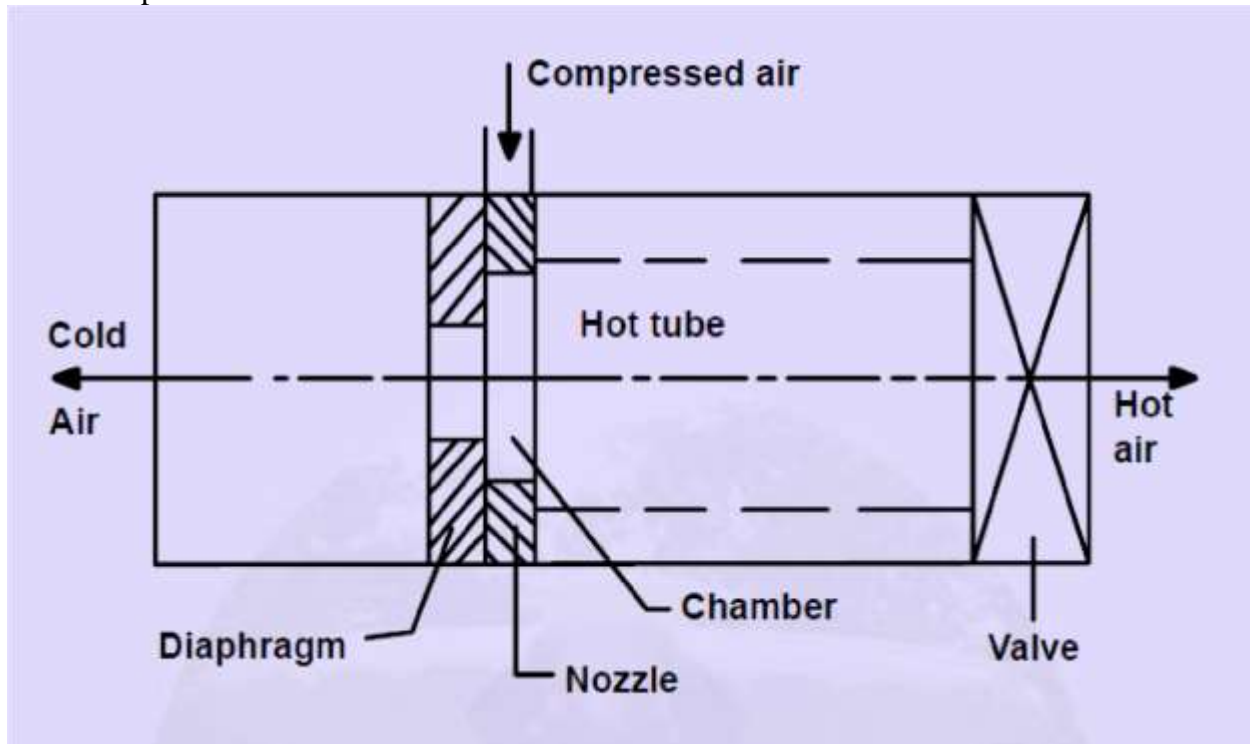

Working:

Compressed air is passed through the nozzle as shown in Fig.6.9. Here, air expands and acquires high velocity due to particular shape of the nozzle. A vortex flow is created in the chamber and air travels in spiral like motion along the periphery of the hot side. This flow is restricted by the valve. When the pressure of the air near valve is made more than outside by partly closing the valve, a reversed axial flow through the core of the hot side starts from high-pressure region to low-pressure region. During this process, heat transfer takes place between reversed stream and forward stream. Therefore, air stream through the core gets cooled below the inlet temperature of the air in the vortex tube, while air stream in forward direction gets heated up. The cold stream is escaped through the diaphragm hole into the cold side, while hot stream is passed through the opening of the valve. By controlling the opening of the valve, the quantity of the cold air and its temperature can be varied.

Advantages:

- 1) *It uses air as refrigerant, so there is no leakage problem.*
- 2) *Vortex tube is simple in design and it avoids control systems.*
- 3) *There are no moving parts in vortex tube.*
- 4) *It is light in weight and requires less space.*
- 5) *Initial cost is low and its working expenses are also less, where compressed air is readily available.*
- 6) *Maintenance is simple and no skilled labours are required.*

Disadvantages:

Its low COP, limited capacity and only small portion of the compressed air appearing as the cold air limits its wide use in practice.

Thermoelectric Refrigeration

Thermoelectric refrigeration is a novel method of producing low temperatures and is based on the reverse Seebeck effect.

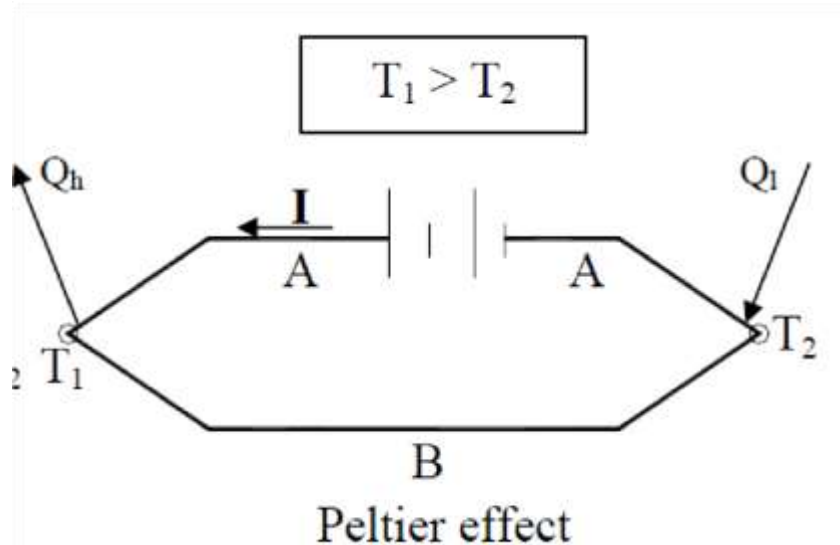

When a battery is added in between the two conductors A and B whose junctions are initially at same temperature, and a current is made to flow through the circuit, the junction temperatures will change, one junction becoming hot (T_1) and the other becoming cold (T_2). This effect is known as Peltier effect. Refrigeration effect is obtained at the cold junction and heat is rejected to the surroundings at the hot junction. This is the basis for thermoelectric refrigeration systems.

The position of hot and cold junctions can be reversed by reversing the direction of current flow. The heat transfer rate at each junction is given by:

$$Q = \phi I$$

where ϕ is the Peltier coefficient in volts and I is the current in amperes.

Selection of suitable material is very important in the design of efficient thermoelectric refrigeration systems. Ideal thermoelectric materials should have high electrical conductivity and low thermal conductivity. Pure metals are not good due to their high thermal conductivity, while insulating materials are not good due to their low electrical conductivity. Thermoelectric refrigeration systems became commercial with the development of semiconductor materials, which typically have reasonably high electrical conductivity and low thermal conductivity. Thermoelectric refrigeration systems based on semiconductors consist of p-type and n-type materials. The p-type materials have positive thermoelectric power α_p , while the n-type materials have negative thermoelectric power, α_n . By carrying out a simple thermodynamic analysis it was shown that the temperature difference between hot and cold junctions ($T_2 - T_1$), rate of refrigeration Q_c and COP of a thermoelectric refrigeration system are given by:

$$(T_2 - T_1) = \frac{(\alpha_p - \alpha_n)T_1 I - \dot{Q}_1 - \frac{1}{2}I^2 R}{U}$$

$$\dot{Q}_1 = (\alpha_p - \alpha_n)T_1 I - U(T_2 - T_1) - \frac{1}{2}I^2 R$$

$$\text{COP} = \frac{\dot{Q}_1}{W} = \frac{(\alpha_p - \alpha_n)T_1 I - U(T_2 - T_1) - \frac{1}{2}I^2 R}{(\alpha_p - \alpha_n)(T_2 - T_1)I + I^2 R}$$

where \dot{Q}_1 is the rate of refrigeration (W) obtained at temperature T_1 . \dot{Q}_1 , W is the power input by the battery (W) and U is the effective thermal conductance between the two junctions.

An optimum current can be obtained by maximizing each of the above performance parameters, i.e., temperature difference, refrigeration effect and COP. For example, differentiating the expression for COP with respect to I and equating it zero, we get the expressions for optimum current and maximum COP as:

$$I_{\text{opt}} = \frac{(\alpha_p - \alpha_n)(T_2 - T_1)}{R(\sqrt{1 + ZT_m} - 1)}$$

$$\text{COP}_{\text{max}} = \frac{\left(\frac{T_1}{T_2 - T_1}\right)(\sqrt{1 + ZT_m} - \frac{T_2}{T_1})}{(\sqrt{1 + ZT_m} + 1)}$$

where Z is a property parameter called figure of merit and T_m is the mean of T_2 and T_1 . The figure of merit Z is given by:

$$Z = \frac{(\alpha_p - \alpha_n)^2}{UR}$$

It can be shown that for best performance the figure of merit Z should be as high as possible.

MODULE 4

Atmospheric air makes up the environment in almost every type of air conditioning system. Hence a thorough understanding of the properties of atmospheric air and the ability to analyze various processes involving air is fundamental to air conditioning design.

Psychrometry is the study of the properties of mixtures of air and water vapour.

Atmospheric air is a mixture of many gases plus water vapour and a number of pollutants. The amount of water vapour and pollutants vary from place to place. The concentration of water vapour and pollutants decrease with altitude, and above an altitude of about 10 km, atmospheric air consists of only dry air. The pollutants have to be filtered out before processing the air. Hence, what we process is essentially a mixture of various gases that constitute air and water vapour. This mixture is known as moist air.

Constituent	Molecular weight	Mol fraction
Oxygen	32.000	0.2095
Nitrogen	28.016	0.7809
Argon	39.944	0.0093
Carbon dioxide	44.010	0.0003

The moist air can be thought of as a mixture of dry air and moisture. For all practical purposes, the composition of dry air can be considered as constant.

Based on the above composition the molecular weight of dry air is found to be 28.966 and the gas constant R is 287.035 J/kg.K. For calculation purposes, the molecular weight of water vapour is taken as 18.015 and its gas constant is 461.52 J/kg.K.

Basic gas laws for moist air:

According to the Gibbs-Dalton law for a mixture of perfect gases, the total pressure exerted by the mixture is equal to the sum of partial pressures of the constituent gases. According to this law, for a homogeneous perfect gas mixture occupying a volume V and at temperature T , each constituent gas behaves as though the other gases are not present (i.e., there is no interaction between the gases). Each gas obeys perfect gas equation. Hence, the partial pressures exerted by each gas, $p_1, p_2, p_3 \dots$ and the total pressure p_t are given by:

$$p_1 = \frac{n_1 R_u T}{V}; p_2 = \frac{n_2 R_u T}{V}; p_3 = \frac{n_3 R_u T}{V} \dots\dots$$

$$p_t = p_1 + p_2 + p_3 + \dots\dots$$

where n_1, n_2, n_3, \dots are the number of moles of gases 1, 2, 3, ...

Applying this equation to moist air.

$$p = p_t = p_a + p_v$$

where $p = p_t =$ total barometric pressure
 $p_a =$ partial pressure of dry air
 $p_v =$ partial pressure of water vapour

Important psychrometric properties:

Dry bulb temperature (DBT): is the temperature of the moist air as measured by a standard thermometer or other temperature measuring instruments.

Saturated vapour pressure (psat): is the saturated partial pressure of water vapour at the dry bulb temperature. This is readily available in thermodynamic tables and charts. ASHRAE suggests the following regression equation for saturated vapour pressure of water, which is valid for 0 to 100° C.

$$\ln(p_{\text{sat}}) = \frac{c_1}{T} + c_2 + c_3 T + c_4 T^2 + c_5 T^3 + c_6 \ln(T)$$

where p_{sat} = saturated vapor pressure of water in kiloPascals
 T = temperature in K

The regression coefficients c_1 to c_6 are given by:

$$c_1 = -5.80022006E+03, c_2 = -5.516256E+00, c_3 = -4.8640239E-02$$

$$c_4 = 4.1764768E-05, c_5 = -1.4452093E-08, c_6 = 6.5459673E+00$$

Relative humidity (Φ): is defined as the ratio of the mole fraction of water vapour in moist air to mole fraction of water vapour in saturated air at the same temperature and pressure. Using perfect gas equation we can show that:

$$\phi = \frac{\text{partial pressure of water vapour}}{\text{saturation pressure of pure water vapour at same temperature}} = \frac{p_v}{p_{\text{sat}}}$$

Relative humidity is normally expressed as a percentage. When Φ is 100 percent, the air is saturated.

Humidity ratio (ω): The humidity ratio (or specific humidity) ω is the mass of water associated with each kilogram of dry air. Assuming both water vapour and dry air to be perfect gases, the humidity ratio is given by:

$$W = \frac{\text{kg of water vapour}}{\text{kg of dry air}} = \frac{p_v V / R_v T}{p_a V / R_a T} = \frac{p_v / R_v}{(p_t - p_v) / R_a}$$

Substituting the values of gas constants of water vapour and air R_v and R_a in the above equation; the humidity ratio is given by:

$$W = 0.622 \frac{p_v}{p_t - p_v}$$

For a given barometric pressure p_t , given the DBT, we can find the saturated vapour pressure p_{sat} from the thermodynamic property tables on steam. Then using the above equation, we can find the humidity ratio at saturated conditions, ω_{sat} . It is to be noted that, ω is a function of both total barometric pressure and vapor pressure of water.

Dew-point temperature: If unsaturated moist air is cooled at constant pressure, then the temperature at which the moisture in the air begins to condense is known as dew-point temperature (DPT) of air. The dew point temperature is the saturation temperature corresponding to the vapour pressure of water vapour.

Degree of saturation μ : The degree of saturation is the ratio of the humidity ratio ω to the humidity ratio of a saturated mixture ω_s at the same temperature and pressure, i.e.,

$$\mu = \left| \frac{W}{W_s} \right|_{t,P}$$

Enthalpy: The enthalpy of moist air is the sum of the enthalpy of the dry air and the enthalpy of the water vapour. Enthalpy values are always based on some reference value. For moist air, the enthalpy of dry air is given a zero value at 0°C, and for water vapour the enthalpy of saturated water is taken as zero at 0°C. The enthalpy of moist air is given by:

$$h = h_a + Wh_g = c_p t + W(h_{fg} + c_{pw} t)$$

where c_p	= specific heat of dry air at constant pressure, kJ/kg.K
c_{pw}	= specific heat of water vapor, kJ/kg.K
t	= Dry-bulb temperature of air-vapor mixture, °C
W	= Humidity ratio, kg of water vapor/kg of dry air
h_a	= enthalpy of dry air at temperature t , kJ/kg
h_g	= enthalpy of water vapor ³ at temperature t , kJ/kg
h_{fg}	= latent heat of vaporization at 0°C, kJ/kg

The unit of h is kJ/kg of dry air. Substituting the approximate values of c_p and h_g , we obtain:

$$h = 1.005 t + W(2501 + 1.88t)$$

Humid specific heat: From the equation for enthalpy of moist air, the humid specific heat of moist air can be written as:

$$c_{pm} = c_p + W.c_{pw}$$

where c_{pm}	=	humid specific heat, kJ/kg.K
c_p	=	specific heat of dry air, kJ/kg.K
c_{pw}	=	specific heat of water vapor, kJ/kg
W	=	humidity ratio, kg of water vapor/kg of dry air

Since the second term in the above equation ($W.c_{pw}$) is very small compared to the first term, for all practical purposes, the humid specific heat of moist air, c_{pm} can be taken as 1.0216 kJ/kg dry air.K

Specific volume: The specific volume is defined as the number of cubic meters of moist air per kilogram of dry air. From perfect gas equation since the volumes occupied by the individual substances are the same, the specific volume is also equal to the number of cubic meters of dry air per kilogram of dry air, i.e.,

$$v = \frac{R_a T}{p_a} = \frac{R_a T}{p_t - p_v} \quad \text{m}^3 / \text{kg dry air}$$

Thermodynamic wet bulb temperature: After the adiabatic saturator has achieved a steady-state condition, the temperature indicated by the thermometer immersed in the water is the thermodynamic wet-bulb temperature. The thermodynamic wet bulb temperature will be less than the entering air DBT but greater than the dew point temperature. It is to be observed that the thermodynamic wet-bulb temperature is a thermodynamic property, and is independent of the path taken by air. Assuming the humid specific heat to be constant, from the enthalpy balance, the thermodynamic wet-bulb temperature can be written as:

$$t_2 = t_1 - \frac{h_{fg,2}}{c_{pm}} (w_2 - w_1)$$

Psychrometric chart:

A Psychrometric chart graphically represents the thermodynamic properties of moist air. Standard psychrometric charts are bounded by the dry-bulb temperature line (abscissa) and the vapour pressure or humidity ratio (ordinate). The Left Hand Side of the psychrometric chart is bounded by the saturation line. Figure shows the schematic of a psychrometric chart. Psychrometric charts are readily available for standard barometric pressure of 101.325 kPa at sea level and for normal temperatures (0-50° C). ASHRAE has also developed psychrometric charts for other temperatures and barometric pressures (for low temperatures: -40 to 10° C, high temperatures 10 to 120° C and very high temperatures 100 to 120° C).

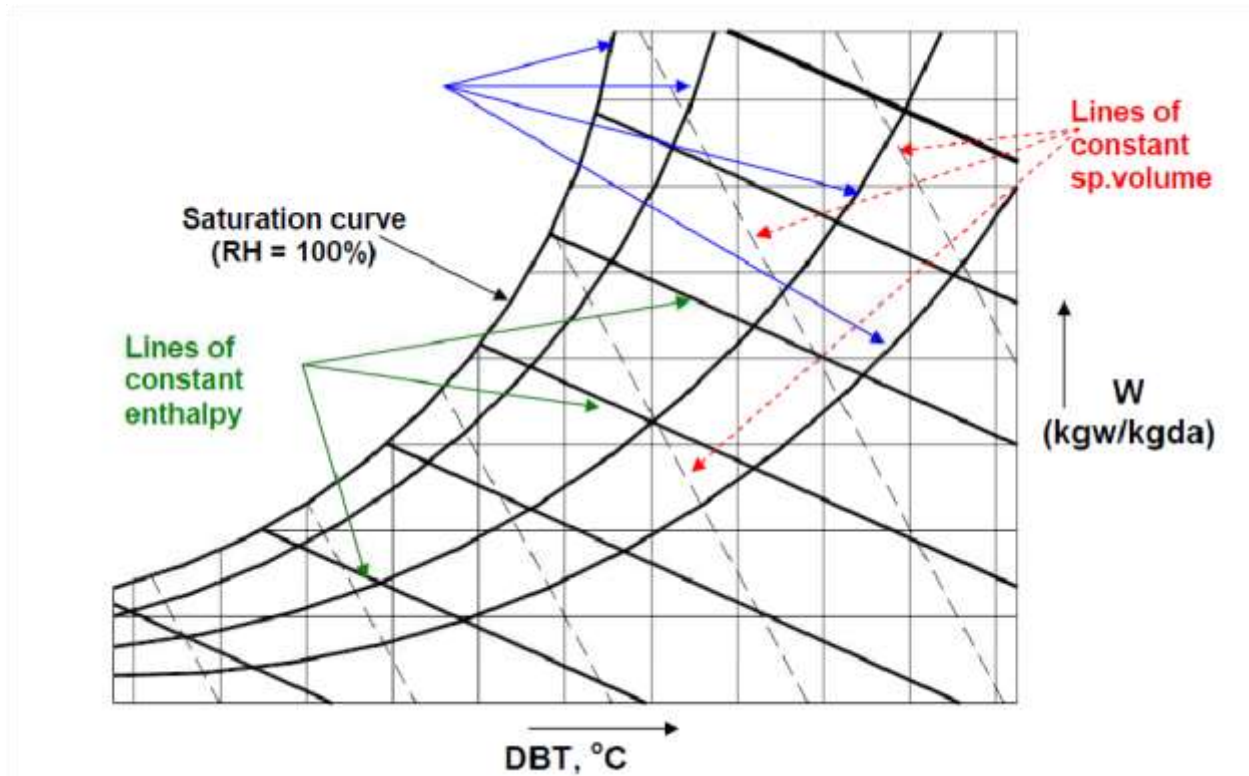

Measurement of psychrometric properties:

Based on Gibbs' phase rule, the thermodynamic state of moist air is uniquely fixed if the barometric pressure and two other independent properties are known. This means that at a given barometric pressure, the state of moist air can be determined by measuring any two independent properties. One of them could be the dry-bulb temperature (DBT), as the measurement of this temperature is fairly simple and accurate. The accurate measurement of other independent parameters such as humidity ratio is very difficult in practice. Since measurement of temperatures is easier, it would be convenient if the other independent parameter is also a temperature. Of course, this could be the dew-point temperature (DPT), but it is observed that accurate measurement of dew-point temperature is difficult. In this context, a new independent temperature parameter called the wet-bulb temperature (WBT) is defined. Compared to DPT, it is easier to measure the wet-bulb temperature of moist air. Thus knowing the dry-bulb and wetbulb temperatures from measurements, it is possible to find the other properties of moist air.

Calculation of psychrometric properties from p, DBT and WBT:

As mentioned before, to fix the thermodynamic state of moist air, we need to know three independent properties. The properties that are relatively easier to measure, are: the barometric pressure, dry-bulb temperature and wet-bulb temperature. For a given barometric pressure, knowing the dry bulb and wet bulb temperatures, all other properties can be easily calculated

from the psychrometric equations. The following are the empirical relations for the vapor pressure of water in moist air:

iii) Carrier equation:

$$p_v = p'_v - \frac{1.8(p - p'_v)(t - t')}{2800 - 1.3(1.8t + 32)}$$

where t = dry bulb temperature, °C
 t' = wet bulb temperature, °C
 p = barometric pressure
 p_v = vapor pressure
 p'_v = saturation vapor pressure at wet-bulb temperature

The units of all the pressures in the above equations should be consistent.

Once the vapor pressure is calculated, then all other properties such as relative humidity, humidity ratio, enthalpy, humid volume etc. can be calculated from the psychrometric equations presented earlier.

Important psychrometric processes:

a) Sensible cooling:

During this process, the moisture content of air remains constant but its temperature decreases as it flows over a cooling coil. For moisture content to remain constant, the surface of the cooling coil should be dry and its surface temperature should be greater than the dew point temperature of air. If the cooling coil is 100% effective, then the exit temperature of air will be equal to the coil temperature. However, in practice, the exit air temperature will be higher than the cooling coil temperature. Figure shows the sensible cooling process O-A on a psychrometric chart. The heat transfer rate during this process is given by:

$$Q_c = m_a(h_O - h_A) = m_a c_{pm}(T_O - T_A)$$

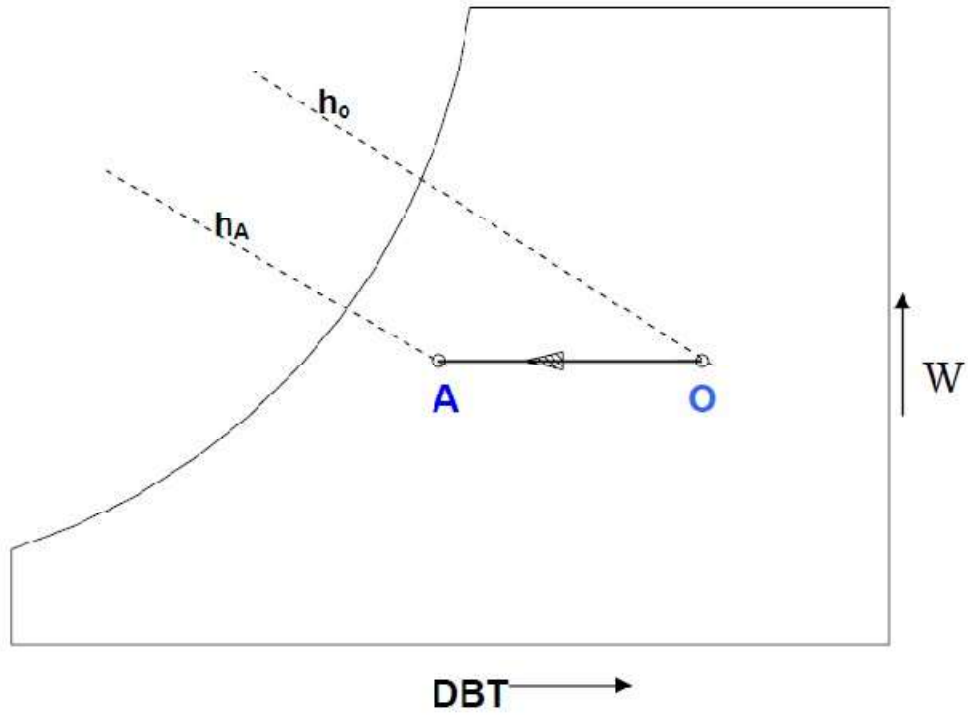

b) Sensible heating (Process O-B):

During this process, the moisture content of air remains constant and its temperature increases as it flows over a heating coil. The heat transfer rate during this process is given by:

$$Q_h = m_a (h_B - h_O) = m_a c_{pm} (T_B - T_O)$$

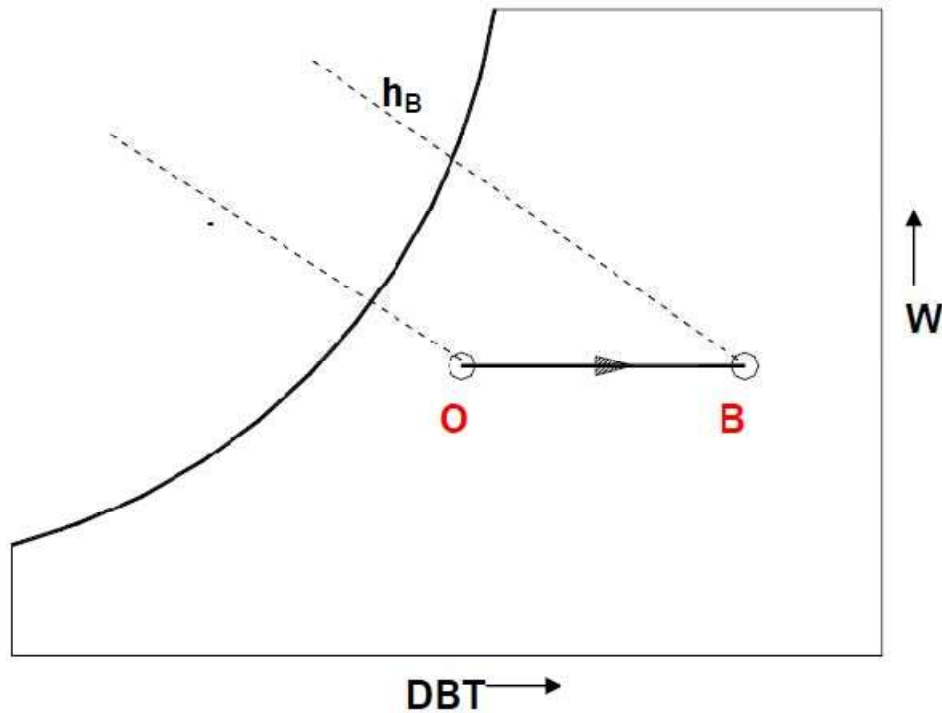

where c_{pm} is the humid specific heat (≈ 1.0216 kJ/kg dry air) and m_a is the mass flow rate of dry air (kg/s). Figure shows the sensible heating process on a psychrometric chart.

c) Cooling and dehumidification (Process O-C):

When moist air is cooled below its dew-point by bringing it in contact with a cold surface as shown in Fig., some of the water vapor in the air condenses and leaves the air stream as liquid, as a result both the temperature and humidity ratio of air decreases as shown. This is the process air undergoes in a typical air conditioning system. Although the actual process path will vary depending upon the type of cold surface, the surface temperature, and flow conditions, for simplicity the process line is assumed to be a straight line.

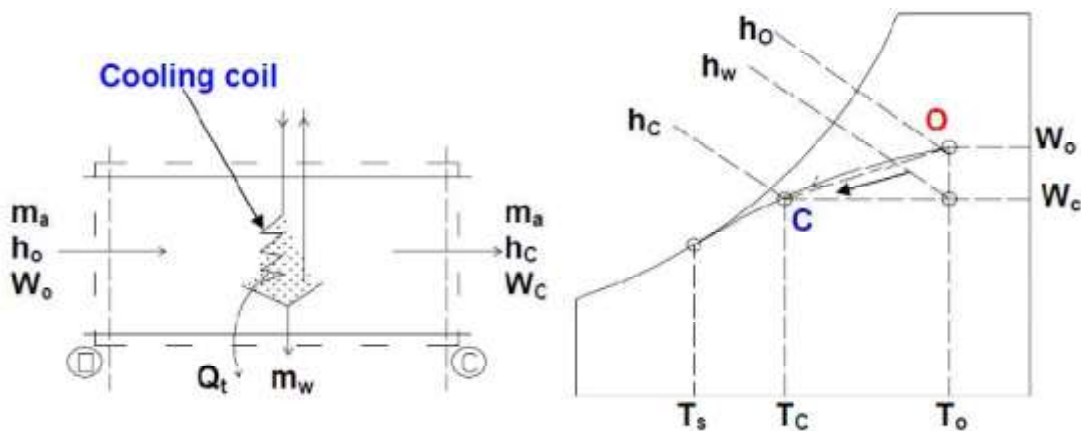

The heat and mass transfer rates can be expressed in terms of the initial and final conditions by applying the conservation of mass and conservation of energy equations as given below:

$$m_a \cdot w_o = m_a \cdot w_c + m_w$$

By applying energy balance:

$$m_a \cdot h_o = Q_t + m_w \cdot h_w + m_a \cdot h_c$$

from the above two equations, the load on the cooling coil, Q_t is given by:

$$Q_t = m_a (h_o - h_c) - m_a (w_o - w_c) h_w$$

It can be observed that the cooling and de-humidification process involves both latent and sensible heat transfer processes, hence, the total, latent and sensible heat transfer rates (Q_t , Q_l and Q_s) can be written as:

$$Q_t = Q_l + Q_s$$

where

$$Q_l = m_a (h_o - h_w) = m_a \cdot h_{fg} (w_o - w_c)$$

$$Q_s = m_a (h_w - h_c) = m_a \cdot c_{pm} (T_o - T_c)$$

By separating the total heat transfer rate from the cooling coil into sensible and latent heat transfer rates, a useful parameter called Sensible Heat Factor (SHF) is defined. SHF is defined as the ratio of sensible to total heat transfer rate, i.e.,

$$SHF = Q_s / Q_t = Q_s / (Q_s + Q_l)$$

From the above equation, one can deduce that a SHF of 1.0 corresponds to no latent heat transfer and a SHF of 0 corresponds to no sensible heat transfer. A SHF of 0.75 to 0.80 is quite common in air conditioning systems in a normal dry-climate. A lower value of SHF, say 0.6, implies a high latent heat load such as that occurs in a humid climate.

From Fig., it can be seen that the slope of the process line O-C is given by:

$$\tan c = \frac{\Delta w}{\Delta T}$$

From the definition of SHF,

$$\frac{1 - \text{SHF}}{\text{SHF}} = \frac{Q_l}{Q_s} = \frac{m_a h_{fg} \Delta w}{m_a c_{pm} \Delta T} = \frac{2501 \Delta w}{1.0216 \Delta T} = 2451 \frac{\Delta w}{\Delta T}$$

From the above equations, we can write the slope as:

$$\tan c = \frac{1}{2451} \left(\frac{1 - \text{SHF}}{\text{SHF}} \right)$$

In Fig., the temperature T_s is the effective surface temperature of the cooling coil, and is known as apparatus dew-point (ADP) temperature. In an ideal situation, when all the air comes in perfect contact with the cooling coil surface, then the exit temperature of air will be same as ADP of the coil. However, in actual case the exit temperature of air will always be greater than the apparatus dew-point temperature due to boundary layer development as air flows over the cooling coil surface and also due to temperature variation along the fins etc. Hence, we can define a by-pass factor (BPF) as:

$$\text{BPF} = \frac{T_c - T_s}{T_o - T_s}$$

It can be easily seen that, higher the by-pass factor larger will be the difference between air outlet temperature and the cooling coil temperature. When BPF is 1.0, all the air by-passes the coil and there will not be any cooling or de-humidification. In practice, the by-pass factor can be increased by increasing the number of rows in a cooling coil or by decreasing the air velocity or by reducing the fin pitch.

Alternatively, a contact factor (CF) can be defined which is given by:

$$\text{CF} = 1 - \text{BPF}$$

d) Heating and Humidification (Process O-D):

During winter it is essential to heat and humidify the room air for comfort. As shown in Fig., this is normally done by first sensibly heating the air and then adding water vapour to the air stream through steam nozzles as shown in the figure.

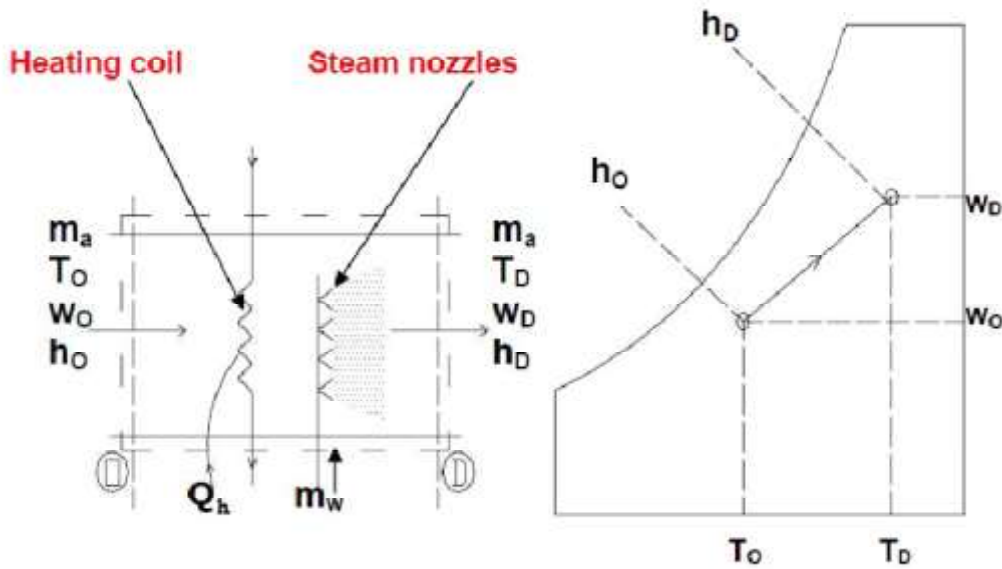

Mass balance of water vapor for the control volume yields the rate at which steam has to be added, i.e., m_w :

$$m_w = m_a (w_D - w_o)$$

where m_a is the mass flow rate of dry air.

From energy balance:

$$Q_h = m_a (h_D - h_o) - m_w h_w$$

where Q_h is the heat supplied through the heating coil and h_w is the enthalpy of steam.

Since this process also involves simultaneous heat and mass transfer, we can define a sensible heat factor for the process in a way similar to that of a cooling and dehumidification process.

e) Cooling & humidification (Process O-E):

As the name implies, during this process, the air temperature drops and its humidity increases. This process is shown in Fig.28.6. As shown in the figure, this can be achieved by spraying cool water in the air stream. The temperature of water should be lower than the dry-bulb temperature. It can be seen that during this process there is sensible heat transfer from air to water and latent heat transfer from water to air. Hence, the total heat transfer depends upon the water temperature. If the temperature of the water sprayed is equal to the wet-bulb temperature of air, then the net transfer rate will be zero as the sensible heat transfer from air to water will be equal to latent heat transfer from water to air. If the water temperature is greater than WBT, then there will be a net heat transfer from water to air. If the water temperature is less than WBT, then the net heat transfer will be from air to water. Under a special case when the spray water is entirely recirculated and is neither heated nor cooled, the system is perfectly insulated and the make-up water is supplied at WBT, then at steady-state, the air undergoes an adiabatic saturation process, during which its WBT remains constant. The process of cooling and humidification is encountered in a wide variety of devices such as evaporative coolers, cooling towers etc. of air but higher than its dew-point temperature to avoid condensation ($T_{DPT} < T_w < T_o$).

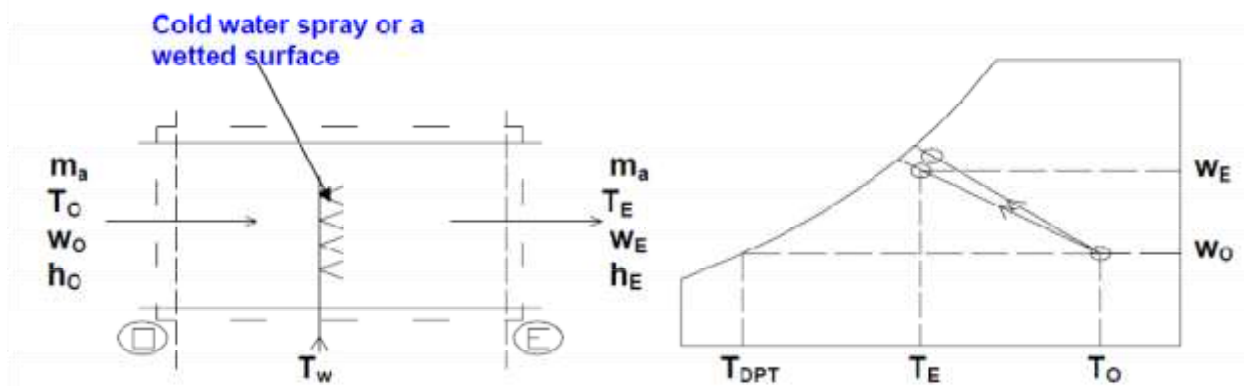

f) Heating and de-humidification (Process O-F):

This process can be achieved by using a hygroscopic material, which absorbs or adsorbs the water vapor from the moisture. If this process is thermally isolated, then the enthalpy of air remains constant, as a result the temperature of air increases as its moisture content decreases as shown in Fig. This hygroscopic material can be a solid or a liquid. In general, the absorption of water by the hygroscopic material is an exothermic reaction, as a result heat is released during this process, which is transferred to air and the enthalpy of air increases.

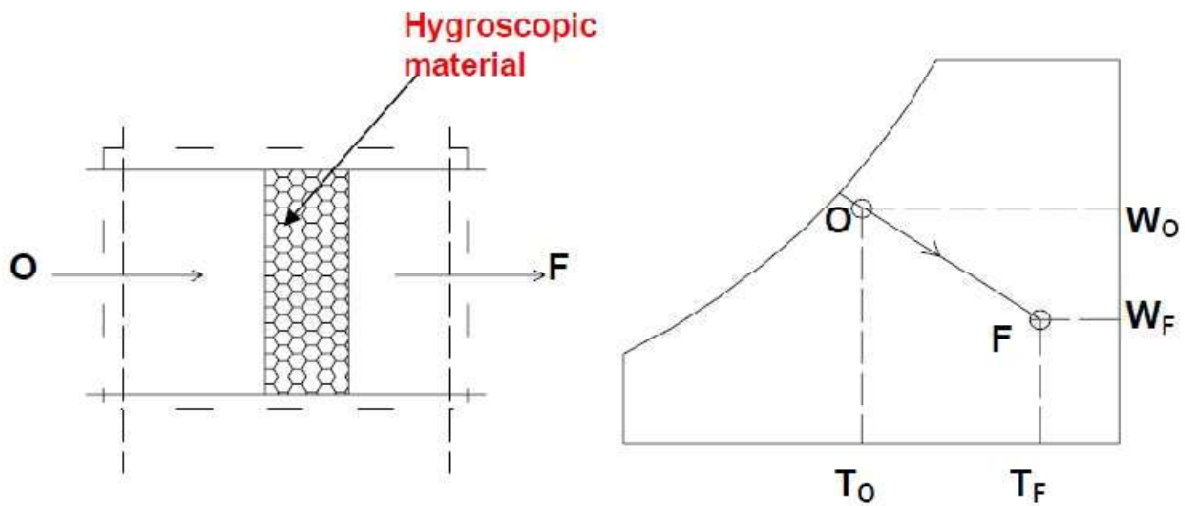

g) Mixing of air streams:

Mixing of air streams at different states is commonly encountered in many processes, including in air conditioning. Depending upon the state of the individual streams, the mixing process can take place with or without condensation of moisture.

i) Without condensation: Figure shows an adiabatic mixing of two moist air streams during which no condensation of moisture takes place. As shown in the figure, when two air streams at state points 1 and 2 mix, the resulting mixture condition 3 can be obtained from mass and energy balance.

From the mass balance of dry air and water vapor:

$$m_{a,1}w_1 + m_{a,2}w_2 = m_{a,3}w_3 = (m_{a,1} + m_{a,2})w_3$$

From energy balance:

$$m_{a,1}h_1 + m_{a,2}h_2 = m_{a,3}h_3 = (m_{a,1} + m_{a,2})h_3$$

From the above equations, it can be observed that the final enthalpy and humidity ratio of mixture are weighted averages of inlet enthalpies and humidity ratios. A generally valid approximation is that the final temperature of the mixture is the weighted average of the inlet temperatures. With this approximation, the point on the psychrometric chart representing the

mixture lies on a straight line connecting the two inlet states. Hence, the ratio of distances on the line, i.e., (1-3)/(2-3) is equal to the ratio of flow rates $m_{a,2}/m_{a,1}$. The resulting error (due to the assumption that the humid specific heats being constant) is usually less than 1 percent.

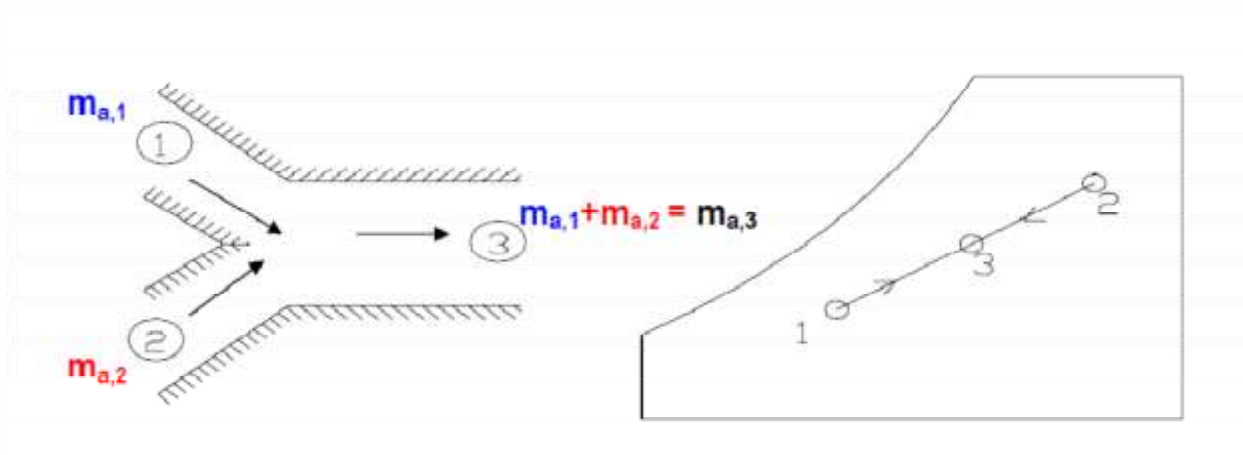

Air Washers:

An air washer is a device for conditioning air. As shown in Fig., in an air washer air comes in direct contact with a spray of water and there will be an exchange of heat and mass (water vapour) between air and water. The outlet condition of air depends upon the temperature of water sprayed in the air washer. Hence, by controlling the water temperature externally, it is possible to control the outlet conditions of air, which then can be used for air conditioning purposes.

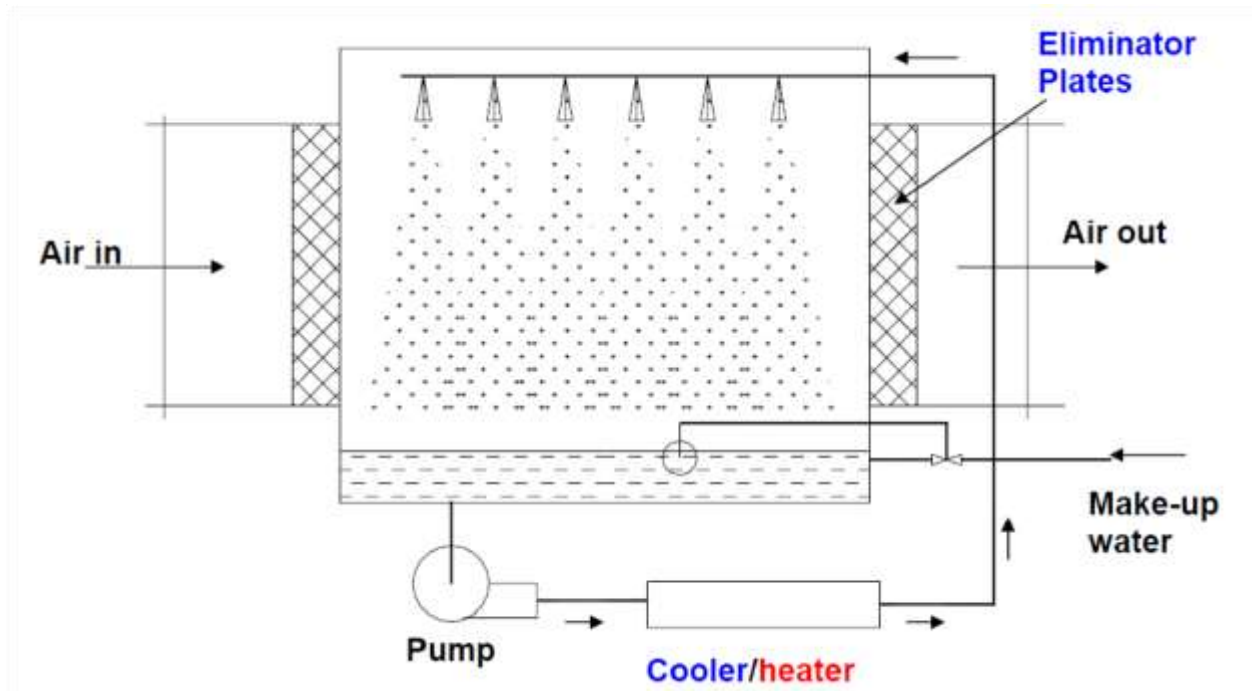

In the air washer, the mean temperature of water droplets in contact with air decides the direction of heat and mass transfer. As a consequence of the 2nd law, the heat transfer between air and water droplets will be in the direction of decreasing temperature gradient. Similarly, the mass transfer will be in the direction of decreasing vapor pressure gradient. For example

a) Cooling and dehumidification: $t_w < t_{DPT}$. Since the exit enthalpy of air is less than its inlet value, from energy balance it can be shown that there is a transfer of total energy from air to water. Hence to continue the process, water has to be externally cooled. Here both latent and sensible heat transfers are from air to water. This is shown by Process O-A in Fig..

b) Adiabatic saturation: $t_w = t_{WBT}$. Here the sensible heat transfer from air to water is exactly equal to latent heat transfer from water to air. Hence, no external cooling or heating of water is required. That is this is a case of pure water recirculation. This is shown by Process O-B in Fig.28.11. This the process that takes place in a perfectly insulated evaporative cooler.

c) Cooling and humidification: $t_{DPT} < t_w < t_{WBT}$. Here the sensible heat transfer is from air to water and latent heat transfer is from water to air, but the total heat transfer is from air to water, hence, water has to be cooled externally. This is shown by Process O-C in Fig..

d) Cooling and humidification: $t_{WBT} < t_w < t_{DPT}$. Here the sensible heat transfer is from air to water and latent heat transfer is from water to air, but the total heat transfer is from water to air, hence, water has to be heated externally. This is shown by Process O-D in Fig.. This is the process

that takes place in a cooling tower. The air stream extracts heat from the hot water coming from the condenser, and the cooled water is sent back to the condenser.

e) Heating and humidification: $t_w > t_{DBT}$. Here both sensible and latent heat transfers are from water to air, hence, water has to be heated externally. This is shown by Process O-E in Fig..

Thus, it can be seen that an air washer works as a year-round air conditioning system. Though air washer is a and extremely useful simple device, it is not commonly used for comfort air conditioning applications due to concerns about health resulting from bacterial or fungal growth on the wetted surfaces. However, it can be used in industrial applications.

Various psychrometric processes that can take place in an air washer

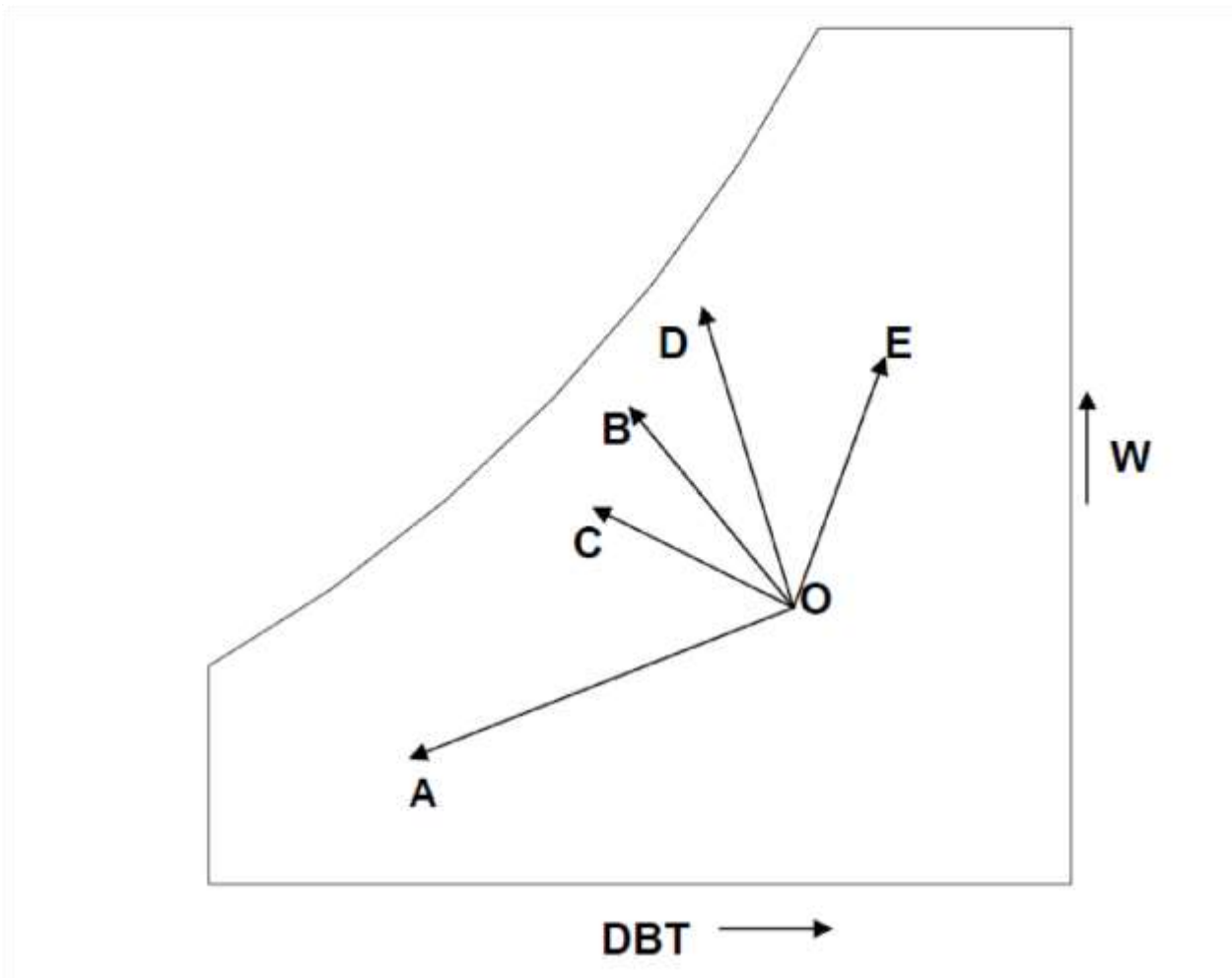

MODULE- 5

Selection of inside design conditions:

Air conditioning is required either for providing suitable comfort conditions for the occupants (e.g. comfort air conditioning), or for providing suitable conditions for storage of perishable products (e.g. in cold storages) or conditions for a process to take place or for products to be manufactured (e.g. industrial air conditioning). The required inside conditions for cold storage and industrial air conditioning applications vary widely depending on the specific requirement. However, the required inside conditions for comfort air conditioning systems remain practically same irrespective of the size, type, location, use of the air conditioning building etc., as this is related to the thermal comfort of the human beings.

Thermal comfort:

Thermal comfort is defined as “that condition of mind which expresses satisfaction with the thermal environment”. This condition is also some times called as “neutral condition”, though in a strict sense, they are not necessarily same. A living human body may be likened to a heat engine in which the chemical energy contained in the food it consumes is continuously converted into work and heat. The process of conversion of chemical energy contained in food into heat and work is called as “metabolism”. The rate at which the chemical energy is converted into heat and work is called as “metabolic rate”. Knowledge of metabolic rate of the occupants is required as this forms a part of the cooling load of the air conditioned building. Continuous heat generation is essential, as the temperature of the human body has to be maintained within a narrow range of temperature, irrespective of the external surroundings.

A human body is very sensitive to temperature. The body temperature must be maintained within a narrow range to avoid discomfort, and within a somewhat wider range, to avoid danger from heat or cold stress. Studies show that at neutral condition, the temperatures should be:

Skin temperature, $t_{\text{skin}} \approx 33.7^{\circ}\text{C}$

Core temperature, $t_{\text{core}} \approx 36.8^{\circ}\text{C}$

At other temperatures, the body will feel discomfort or it may even become lethal. It is observed that when the core temperature is between 35 to 39 C, the body experiences only a mild discomfort.

When the temperature is lower than 35 C or higher than 39 C, then people suffer major loss in efficiency. It becomes lethal when the temperature falls below 31 C or rises above 43 C. This is shown in Fig.

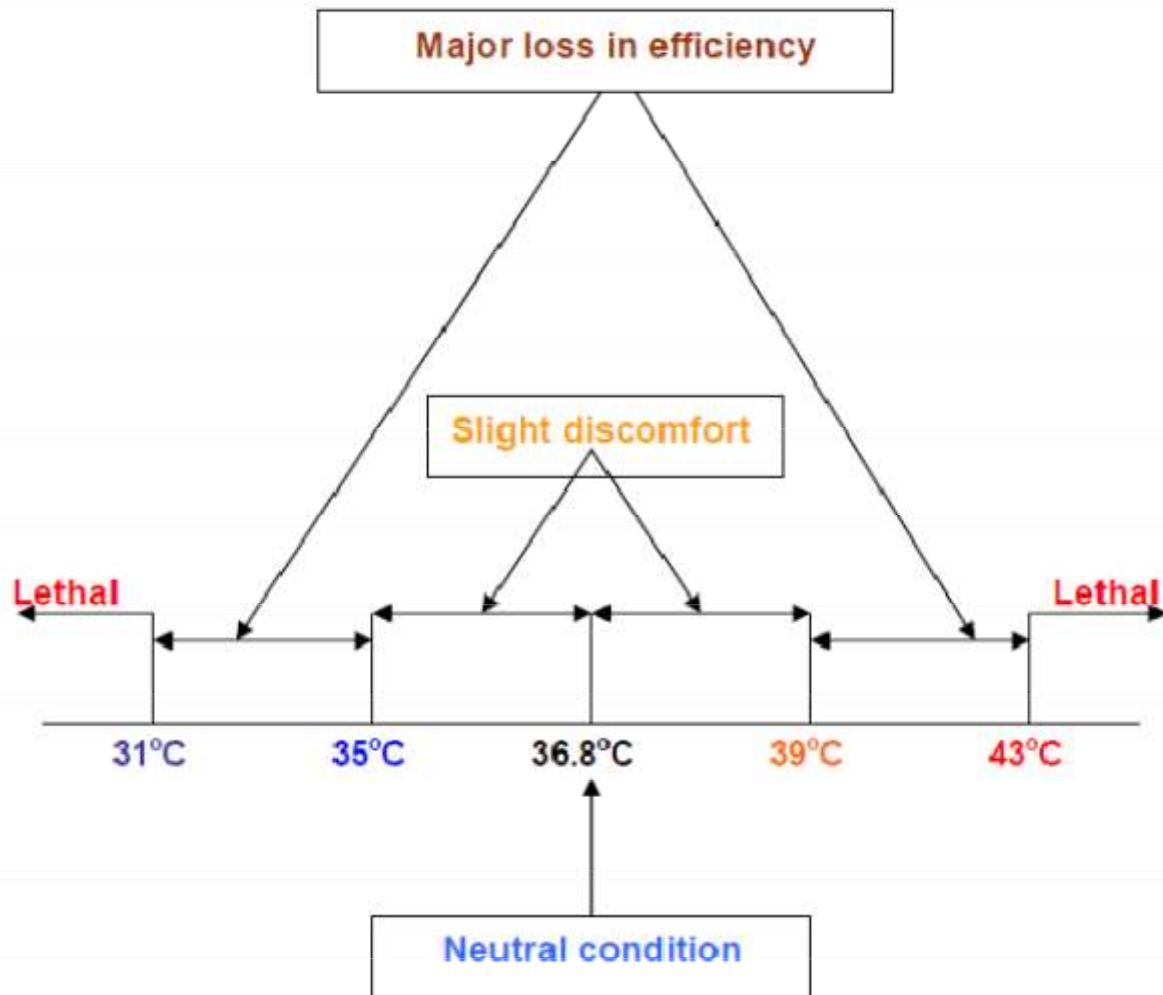

Heat balance equation for a human being:

The temperature of human body depends upon the energy balance between itself and the surrounding thermal environment. Taking the human body as the control volume, one can write the thermal energy (heat) balance equation for the human body as:

$$Q_{gen} = Q_{sk} + Q_{res} + Q_{st}$$

where Q_{gen} = Rate at which heat is generated inside the body

Q_{sk} = Total heat transfer rate from the skin

The heat generation rate Q_{gen} is given by:

$$Q_{\text{gen}} = M(1 - \eta) \approx M$$

Q_{res} = Heat transfer rate due to respiration, and Q_{st}

= Rate at which heat is stored inside the body

where M = Metabolic rate, and η = Thermal

efficiency ≈ 0 for most of the activities

The metabolic rate depends on the activity. It is normally measured in the unit “**met**”. A met is defined as the metabolic rate per unit area of a sedentary person and is found to be equal to about **58.2 W/m²**. This is also known as “basal metabolic rate”. Table shows typical metabolic rates for different activities:

Typical metabolic rates

Activity	Specifications	Metabolic rate
Resting	Sleeping	0.7 met
	Reclining	0.8 met
	Seated, quite	1.0 met
	Standing, relaxed	1.2 met
Walking	0.89 m/s	2.0 met
	1.79 m/s	3.8 met
Office activity	Typing	1.1 met
Driving	Car	1.0 to 2.0 met
	Heavy vehicles	3.2 met
Domestic activities	Cooking	1.6 to 2.0 met
	Washing dishes	1.6 met
	House cleaning	2.0 to 3.4 met
Dancing	-	2.4 to 4.4 met
Teaching	-	1.6 met
Games and sports	Tennis, singles	3.6 to 4.0 met
	Gymnastics	4.0 met
	Basket ball	5.0 to 7.6 met
	Wrestling	7.0 to 8.7 met

Studies show that the metabolic rate can be correlated to the rate of respiratory oxygen consumption and carbon dioxide production. Based on this empirical equations have been developed which relate metabolic rate to O₂ consumption and CO₂ production.

Since the metabolic rate is specified per unit area of the human body (naked body), it is essential to estimate this area to calculate the total metabolic rate. Even though the metabolic rate and heat dissipation are not uniform throughout the body, for calculation purposes they are assumed to be uniform.

The human body is considered to be a cylinder with uniform heat generation and dissipation. The surface area over which the heat dissipation takes place is given by an empirical equation, called as Du Bois Equation. This equation expresses the surface area as a function of the mass and height of the human being. It is given by:

$$A_{Du} = 0.202 m^{0.425} h^{0.725}$$

where A_{Du} = Surface area of the naked body,

m^2 m = Mass of the human being, kg h =

Height of the human being, m

Since the area given by Du Bois equation refers to a naked body, a correction factor must be applied to take the clothing into account. This correction factor, defined as the “ratio of surface area with clothes to surface area without clothes” has been determined for different types of clothing. These values are available in ASHRAE handbooks. Thus from the metabolic rate and the surface area, one can calculate the amount of heat generation, Q_{gen} .

The total heat transfer rate from the skin Q_{sk} is given by:

$$Q_{sk} = \pm Q_{conv} \pm Q_{rad} + Q_{evp}$$

where Q_{conv} = Heat transfer rate due to convection (sensible heat)

Q_{rad} = Heat transfer rate due to radiation (sensible heat), and

Q_{evp} = Heat transfer rate due to evaporation (latent heat)

The convective and radiative heat transfers can be positive or negative, i.e., a body may lose or gain heat by convection and radiation, while the evaporation heat transfer is always positive, i.e., a body always loses heat by evaporation. Using the principles of heat and mass transfer, expressions have been derived for estimating the convective, radiative and evaporative heat transfer rates from a human body. As it can be expected, these heat transfer rates depend on several factors that influence each of the heat transfer mechanism.

According to Belding and Hatch, the convective, radiative and evaporative heat transfer rates from the naked body of an average adult, Q_c , Q_r and Q_e , respectively, are given by:

$$Q_c = 14.8 V^{0.5} (t_b - t)$$

$$Q_r = 11.603 (t_b - t_s)$$

$$Q_e = 181.76 V^{0.4} (p_{s,b} - p_v)$$

In the above equation all the heat transfer rates are in watts, temperatures are in °C and velocity is in m/s; $p_{s,b}$ and p_v are the saturated pressure of water vapour at surface temperature of the body and partial pressure of water vapour in air, respectively, in kPa. From the above equations it is clear that the convective heat transfer from the skin can be increased either by increasing the surrounding air velocity (V) and/or by reducing the surrounding air DBT (t). The radiative heat transfer rate can be increased by reducing the temperature of the surrounding surfaces with which the body exchanges radiation. The evaporative heat transfer rate can be increased by increasing the surrounding air velocity and/or by reducing the moisture content of surrounding air.

The heat transfer rate due to respiration Q_{res} is given by:

$$Q_{res} = C_{res} + E_{res}$$

where C_{res} = Dry heat loss from respiration (sensible, positive or negative)

E_{res} = Evaporative heat loss from respiration (latent, always positive)

The air inspired by a human being is at ambient conditions, while air expired is considered to be saturated and at a temperature equal to the core temperature. Significant heat transfer can occur due to respiration. Correlations have been obtained for dry and evaporative heat losses due to respiration in terms of metabolic rate, ambient conditions etc.

For comfort, the rate of heat stored in the body Q_{st} should be zero, i.e.,

$$Q_{st} = 0 \text{ at neutral condition}$$

However, it is observed that a human body is rarely at steady state, as a result the rate of heat stored in the body is non-zero most of the time. Depending upon the surroundings and factors such as activity level etc., the heat stored is either positive or negative. However, the body cannot sustain long periods of heat storage with a consequent change in body temperatures as discussed before.

Since the body temperature depends on the heat balance, which in turn depends on the conditions in the surroundings, it is important that the surrounding conditions should be such that the body is able to maintain the thermal equilibrium with minimum regulatory effort. All

living beings have **in-built body regulatory processes against cold and heat**, which to some extent maintains the body temperatures when the external conditions are not favorable. For example, human beings consist of a thermoregulatory system, which tries to maintain the body temperature by initiating certain body regulatory processes against cold and heat

When the environment is colder than the neutral zone, then body loses more heat than is generated. Then the regulatory processes occur in the following order.

1. Zone of vaso-motor regulation against cold (vaso-constriction): Blood vessels adjacent to the skin constrict, reducing flow of blood and transport of heat to the immediate outer surface. The outer skin tissues act as insulators.
2. Zone of metabolic regulation: If environmental temperature drops further, then vaso-motor regulation does not provide enough protection. Hence, through a spontaneous increase of activity and by shivering, body heat generation is increased to take care of the increased heat losses.
3. Zone of inevitable body cooling: If the environmental temperature drops further, then the body is not able to combat cooling of its tissues. Hence the body temperature drops, which could prove to be disastrous. This is called as zone of inevitable body cooling.

When the environment is hotter than the neutral zone, then body loses less heat than is generated. Then the regulatory processes occur in the following order.

1. Zone of vaso-motor regulation against heat (vaso-dilation): Here the blood vessels adjacent to the skin dilate, increasing the flow of blood and transport of heat to the immediate outer surface. The outer skin temperature increases providing a greater temperature for heat transfer by convection and radiation.
2. Zone of evaporative regulation: If environmental temperature increases further, the sweat glands become highly active drenching the body surface with perspiration. If the surrounding air humidity and air velocity permit, then increase in body temperature is prevented by increased evaporation from the skin.
3. Zone of inevitable body heating: If the environmental temperature increases further, then body temperature increases leading to the zone of inevitable body heating. The internal body temperature increases leading several ill effects such as heat exhaustion (with symptoms of fatigue, headache, dizziness, irritability etc.), heat cramps (resulting in loss of body salts due to increased perspiration) and finally heat stroke. Heat stroke could cause permanent damage to the brain or could even be lethal if the body temperature exceeds 43°C.

Thus it is seen that even though human body possesses a regulatory mechanism, beyond certain conditions it becomes ineffective. Hence it is essential to ensure that surrounding conditions are conducive for comfortable and safe living. The purpose of a comfort air conditioning system is

to provide suitable conditions in the occupied space so that it is thermally comfortable to the occupants

Factors affecting thermal comfort:

Thermal comfort is affected by several factors. These are:

1. Physiological factors such as age, activity, sex and health. These factors influence the metabolic rate. It is observed that of these factors, the most important is activity. Other factors are found to have negligible effect on thermal comfort.
2. Insulating factor due to clothing. The type of clothing has strong influence on the rate of heat transfer from the human body. The unit for measuring the resistance offered by clothes is called as “clo”. 1 clo is equal to a resistance of about 0.155 m².K/W. Typical clo values for different types of clothing have been estimated and are available in the form of tables. For example, a typical business suit has a clo value of 1.0, while a pair of shorts has a clo value of about 0.05.
3. Environmental factors. Important factors are the dry bulb temperature, relative humidity, air motion and surrounding surface temperature. Of these the dry bulb temperature affects heat transfer by convection and evaporation, the relative humidity affects heat loss by evaporation, air velocity influences both convective and evaporative heat transfer and the surrounding surface temperature affects the radiative heat transfer.

Apart from the above, other factors such as drafts, asymmetrical cooling or heating, cold or hot floors etc. also affect the thermal comfort. The objective of a comfort air conditioning system is to control the environmental factors so that comfort conditions prevail in the occupied space. It has no control on the physiological and insulating factors. However, wearing suitable clothing may help in reducing the cost of the air conditioning system.

Indices for thermal comfort:

It is seen that important factors which affect thermal comfort are the activity, clothing, air DBT, RH, air velocity and surrounding temperature. It should be noted that since so many factors are involved, many combinations of the above conditions provide comfort. Hence to evaluate the effectiveness of the conditioned space, several comfort indices have been suggested. These indices can be divided into direct and derived indices. The direct indices are the dry bulb temperature, humidity ratio, air velocity and the mean radiant temperature (T_{mrt}).

$$T_{mrt}^4 = T_g^4 + CV^{1/2} (T_g - T_a)$$

The mean radiant temperature T_{mrt} affects the radiative heat transfer and is defined (in K) as:
where:

T_g = Globe temperature measured at steady state by a thermocouple placed at the center of a black painted, hollow cylinder (6" dia) kept in the conditioned space, K. The reading of thermocouple results from a balance of convective and radiative heat exchanges between the surroundings and the globe

T_a = Ambient DBT, K

V = Air velocity in m/s, and

C = A constant, 0.247×10^9

The derived indices combine two or more direct indices into a single factor. Important derived indices are the effective temperature, operative temperature, heat stress index, Predicted Mean Vote (PMV), Percent of People Dissatisfied (PPD) etc.

Effective temperature (ET): This factor combines the effects of dry bulb temperature and air humidity into a single factor. It is defined as the temperature of the environment at 50% RH which results in the same total loss from the skin as in the actual environment. Since this value depends on other factors such as activity, clothing, air velocity and T_{mrt} , a Standard Effective Temperature (SET) is defined for the following conditions:

Clothing = 0.6 clo

Activity = 1.0 met

Air velocity = 0.1 m/s

T_{mrt} = DBT (in

K)

Operative temperature (T_{op}): This factor is a weighted average of air DBT and T_{mrt} into a single op

factor. It is given by:

$$T_{op} = \frac{h_r T_{mrt} + h_c T_{amb}}{h_r + h_c} \approx \frac{T_{mrt} + T_{amb}}{2}$$

where h_r and h_c are the radiative and convective heat transfer coefficients and T_{amb} is the r DBT of air.

ASHRAE has defined a comfort chart based on the effective and operative temperatures. Figure shows the ASHRAE comfort chart with comfort zones for summer and winter conditions. It can be seen from the chart that the comfort zones are bounded by effective temperature lines, a constant RH line of 60% and dew point temperature of 2°C. The upper and lower limits of humidity (i.e. 60% RH and 2°C DPT, respectively) are based on the moisture content related considerations of dry skin, eye irritation, respiratory health and microbial growth. The comfort

chart is based on statistical sampling of a large number of occupants with activity levels less than 1.2 met. On the chart, the region where summer and winter comfort zones overlap, people in winter clothing feel slightly warm and people in summer clothing feel slightly cool. Based on the chart ASHARE makes the following recommendations:

Inside design conditions for Winter:

T_{op} between 20.0 to 23.5°C at a RH of 60%

T_{op} between 20.5 to 24.5°C at a DPT of 2°C

Inside design conditions for Summer:

T_{op} between 22.5 to 26.0°C at a RH of 60%

T_{op} between 23.5 to 27.0°C at a DPT of 2°C

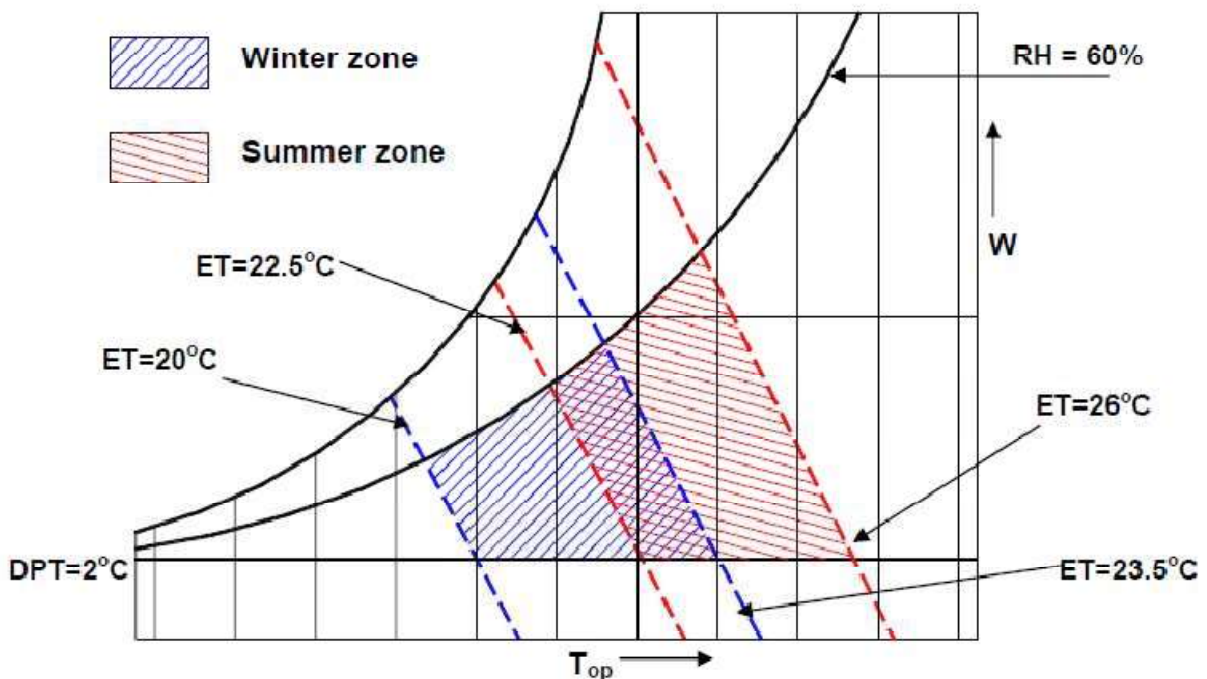

The above values may be considered as recommended inside design conditions for comfort air conditioning. It will be shown later that the **cost of air conditioning (initial plus running) increases as the required inside temperature increases in case of winter and as the required inside condition decreases in case of summer.** Hence, air conditioning systems should be operated at as low a temperature as acceptable in winter and as high a temperature as

acceptable in summer. Use of suitable clothing and maintaining suitable air velocities in the conditioned space can lead to reduced cost of air conditioning. For example, in summer the clothing should be minimal at a socially acceptable level, so that the occupied space can be maintained at higher temperatures. Similarly, by increasing air velocity without causing draft, one can maintain the occupied space at a higher temperature in summer. Similarly, the inside temperatures can be higher for places closer to the equator (1°C rise in ET is allowed for each 5° reduction in latitude). Of course, the above recommendations are for normal activities. The required conditions change if the activity levels are different. For example, when the activity level is high (e.g. in gymnasium), then the required indoor temperatures will be lower. These special considerations must be kept in mind while fixing the inside design conditions. Prof. P.O. Fanger of Denmark has carried out pioneering and detailed studies on thermal comfort and suggested comfort conditions for a wide variety of situations.

Cooling load calculations:

Cooling load calculations involve a systematic and stepwise procedure that takes into account all the relevant building energy flows. The cooling load experienced by a building varies in magnitude from zero (no cooling required) to a maximum value. The design cooling load is a load near the maximum magnitude, but is not normally the maximum. Design cooling load takes into account all the loads experienced by a building under a specific set of assumed conditions.

More accurate load estimation methods involve a combination of analytical methods and empirical results obtained from actual data, for example the use of Cooling Load Temperature Difference (**CLTD**) for estimating fabric heat gain and the use of Solar Heat Gain Factor (**SHGF**) for estimating heat transfer through fenestration. These methods are very widely used by air conditioning engineers as they yield reasonably accurate results and estimations can be carried out manually in a relatively short time. Over the years, more accurate methods that require the use of computers have been developed for estimating cooling loads, e.g. the **Transfer Function Method** (TFM). Since these methods are expensive and time consuming they are generally used for estimating cooling loads of large commercial or institutional buildings. ASHRAE suggests different methods for estimating cooling and heating loads based on applications, such as for residences, for commercial buildings etc.

The assumptions behind design cooling load are as follows:

1. Design outside conditions are selected from a long-term statistical database. The conditions will not necessarily represent any actual year, but are representative of the location of the building. Design data for outside conditions for various locations of the world have been collected and are available in tabular form in various handbooks.
2. The load on the building due to solar radiation is estimated for clear sky conditions.
3. The building *occupancy* is assumed to be *at full design capacity*.

4. All building equipment and appliances are considered to be operating at a reasonably representative capacity.

The total building cooling load consists of heat transferred through the building envelope (walls, roof, floor, windows, doors etc.) and heat generated by occupants, equipment, and lights. The load due to heat transfer through the envelope is called as **external load**, while all other loads are called as **internal loads**. The percentage of external versus internal load varies with building type, site climate, and building design. The total cooling load on any building consists of both **sensible** as well as **latent** load components. The sensible load affects dry bulb temperature, while the latent load affects the moisture content of the conditioned space.

Buildings may be classified as **externally loaded and internally loaded**. In externally loaded buildings the cooling load on the building is mainly due to heat transfer between the surroundings and the internal conditioned space. Since the surrounding conditions are highly variable in any given day, the cooling load of an externally loaded building varies widely. In internally loaded buildings the cooling load is mainly due to internal heat generating sources such as occupants or appliances or processes. In general the heat generation due to internal heat sources may remain fairly constant, and since the heat transfer from the variable surroundings is much less compared to the internal heat sources, the cooling load of an internally loaded building remains fairly constant. Obviously from energy efficiency and economics points of view, the system design strategy for an externally loaded building should be different from an internally loaded building. Hence, prior knowledge of whether the building is externally loaded or internally loaded is essential for effective system design.

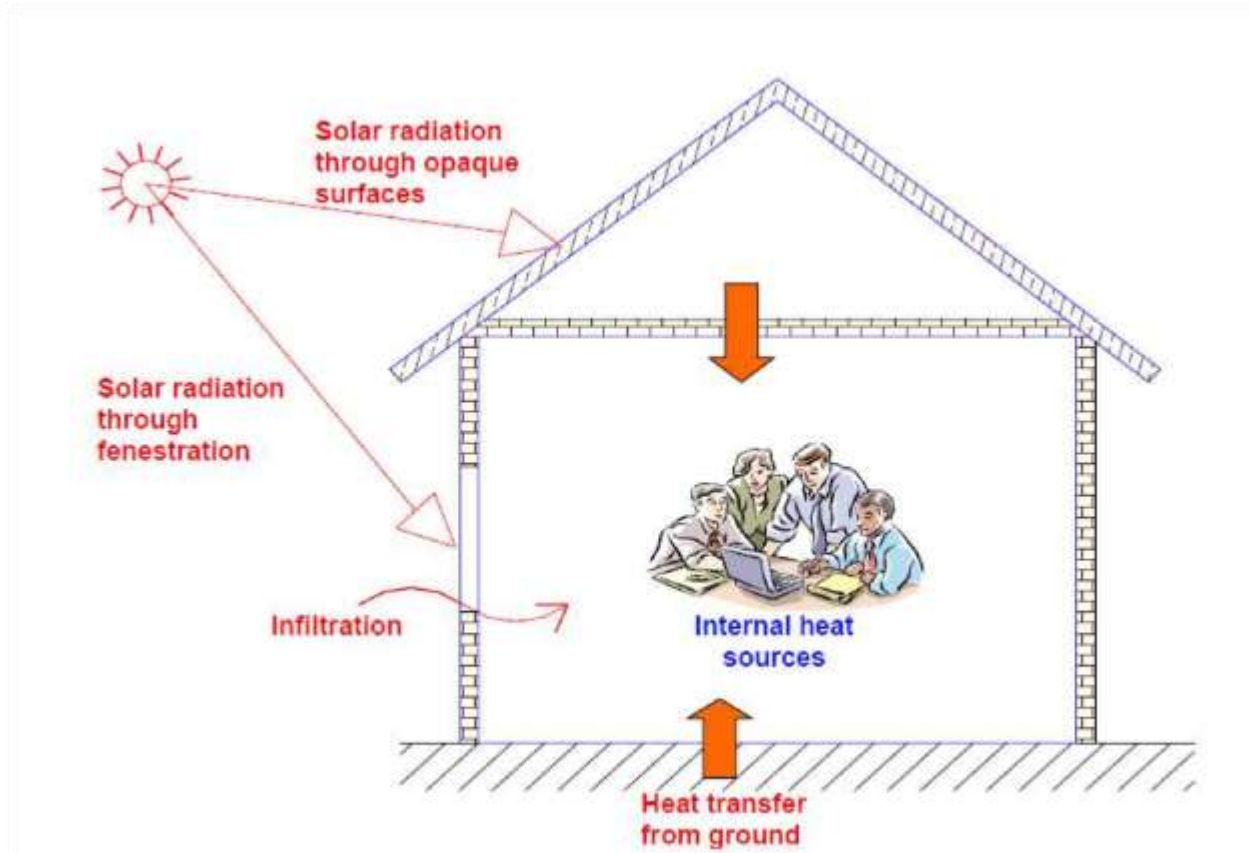

As mentioned before, the total cooling load on a building consists of external as well as internal loads. The external loads consist of heat transfer by conduction through the building walls, roof, floor, doors etc, heat transfer by radiation through fenestration such as windows and skylights. All these are sensible heat transfers. In addition to these the external load also consists of heat transfer due to infiltration, which consists of both sensible as well as latent components. The heat transfer due to ventilation is not a load on the building but a load on the system. The various internal loads consist of sensible and latent heat transfer due to occupants, products, processes and appliances, sensible heat transfer due to lighting and other equipment. Figure 35.1 shows various components that constitute the cooling load on a building.

Estimation of external loads:

a) Heat transfer through opaque surfaces: This is a sensible heat transfer process. The heat transfer rate through opaque surfaces such as walls, roof, floor, doors etc. is given by:

$$Q_{\text{opaque}} = U.A.CLTD$$

where U is the overall heat transfer coefficient and A is the heat transfer area of the surface on the side of the conditioned space. CLTD is the cooling load temperature difference.

For sunlit surfaces, CLTD has to be obtained from the CLTD tables. Adjustment to the values obtained from the table is needed if actual conditions are different from those based on which the CLTD tables are prepared.

For surfaces which are not sunlit or which have negligible thermal mass (such as doors), the CLTD value is simply equal to the temperature difference across the wall or roof. For example, for external doors the CLTD value is simply equal to the difference between the design outdoor and indoor dry bulb temperatures, $T_{out}-T_{in}$.

For interior air conditioned rooms surrounded by non-air conditioned spaces, the CLTD of the interior walls is equal to the temperature difference between the surrounding non-air conditioned space and the conditioned space. Obviously, if an air conditioned room is surrounded by other air conditioned rooms, with all of them at the same temperature, the CLTD values of the walls of the interior room will be zero.

Estimation of CLTD values of floor and roof with false ceiling could be tricky. For floors standing on ground, one has to use the temperature of the ground for estimating CLTD. However, the ground temperature depends on the location and varies with time. ASHRAE suggests suitable temperature difference values for estimating heat transfer through ground. If the floor stands on a basement or on the roof of another room, then the CLTD values for the floor are the temperature difference across the floor (i.e., difference between the temperature of the basement or room below and the conditioned space). This discussion also holds good for roofs which have non-air conditioned rooms above them. For sunlit roofs with false ceiling, the U value may be obtained by assuming the false ceiling to be an air space. However, the CLTD values obtained from the tables may not exactly fit the specific roof. Then one has to use his judgement and select suitable CLTD values.

b) Heat transfer through fenestration: Heat transfer through transparent surface such as a window, includes heat transfer by conduction due to temperature difference across the window and heat transfer due to solar radiation through the window. The heat transfer through the window by convection is calculated using above Eq., with CLTD being equal to the temperature difference across the window and A equal to the total area of the window. The heat transfer due to solar radiation through the window is given by:

$$Q_{trans} = A_{unshaded} \cdot SHGF_{max} \cdot SC \cdot CLF$$

where $A_{unshaded}$ is the area exposed to solar radiation, $SHGF_{max}$ and SC are the maximum Solar Heat Gain Factor and Shading Coefficient, respectively, and CLF is the Cooling Load Factor. The unshaded area has to be obtained from the dimensions of the external shade and solar

geometry. $SHGF_{max}$ and SC are obtained from ASHRAE tables based on the orientation of the window, location, month of the year and the type of glass and internal shading device.

c) Heat transfer due to infiltration: Heat transfer due to infiltration consists of both sensible as well as latent components. The sensible heat transfer rate due to infiltration is given by:

$$Q_{s,inf} = \dot{m}_o c_{p,m} (T_o - T_i) = \dot{V}_o \rho_o c_{p,m} (T_o - T_i)$$

where \dot{V}_o is the infiltration rate (in m^3/s), ρ_o and $c_{p,m}$ are the density and specific heat of the moist, infiltrated air, respectively. T_o and T_i are the outdoor and indoor dry bulb temperatures.

The latent heat transfer rate due to infiltration is given by:

$$Q_{l,inf} = \dot{m}_o h_{fg} (W_o - W_i) = \dot{V}_o \rho_o h_{fg} (W_o - W_i)$$

where h_{fg} is the latent heat of vaporization of water, W_o and W_i are the outdoor and indoor humidity ratio, respectively.

The infiltration rate depends upon several factors such as the tightness of the building that includes the walls, windows, doors etc and the prevailing wind speed and direction. As mentioned before, the infiltration rate is obtained by using either the air change method or the crack method.

The infiltration rate by air change method is given by:

$$\dot{V}_o = (ACH).V / 3600 \quad m^3 / s$$

where **ACH is the number of air changes per hour** and **V is the gross volume of the conditioned space** in m^3 . Normally the ACH value varies from 0.5 ACH for tight and wellsealed buildings to about 2.0 for loose and poorly sealed buildings. For modern buildings the ACH value may be as low as 0.2 ACH. Thus depending upon the age and condition of the building an appropriate ACH value has to be chose, using which the infiltration rate can be calculated.

d) Miscellaneous external loads: In addition to the above loads, if the cooling coil has a positive by-pass factor ($BPF > 0$), then some amount of ventilation air directly enters the conditioned

space, in which case it becomes a part of the building cooling load. The sensible and latent heat transfer rates due to the by-passed ventilation air can be calculated using above equations by replacing with , where is the ventilation rate and BPF is the by-pass factor of the cooling coil.

o. VBPF.Vvent.vent.V

In addition to this, sensible and latent heat transfer to the building also occurs due to heat transfer and air leakage in the supply ducts. A safety factor is usually provided to account for this depending upon the specific details of the supply air ducts.

If the supply duct consists of supply air fan with motor, then power input to the fan becomes a part of the external sensible load on the building. If the duct consists of the electric motor, which drives the fan, then the efficiency of the fan motor also must be taken into account while calculating the cooling load. Most of the times, the power input to the fan is not known *a priori* as the amount of supply air required is not known at this stage. To take this factor into account, initially it is assumed that the supply fan adds about 5% of the room sensible cooling load and cooling loads are then estimated. Then this value is corrected in the end when the actual fan selection is done.

Estimation of internal loads:

The internal loads consist of load due to occupants, due to lighting, due to equipment and appliances and due to products stored or processes being performed in the conditioned space.

a) Load due to occupants: The internal cooling load due to occupants consists of both sensible and latent heat components. The rate at which the sensible and latent heat transfer take place depends mainly on the population and activity level of the occupants. Since a portion of the heat transferred by the occupants is in the form of radiation, a Cooling Load Factor (CLF) should be used similar to that used for radiation heat transfer through fenestration. Thus the sensible heat transfer to the conditioned space due to the occupants is given by the equation:

$$Q_{s, \text{occupants}} = (\text{No. of people}) \cdot (\text{Sensible heat gain / person}) \cdot \text{CLF}$$

Table shows typical values of total heat gain from the occupants and also the sensible heat gain fraction as a function of activity in an air conditioned space. However, it should be noted that the fraction of the total heat gain that is sensible depends on the conditions of the indoor environment. If the conditioned space temperature is higher, then the fraction of total heat gain that is sensible decreases and the latent heat gain increases, and vice versa.

Activity	Total heat gain, W	Sensible heat gain fraction
Sleeping	70	0.75
Seated, quiet	100	0.60
Standing	150	0.50
Walking @ 3.5 kmph	305	0.35
Office work	150	0.55
Teaching	175	0.50
Industrial work	300 to 600	0.35

The value of Cooling Load Factor (CLF) for occupants depends on the hours after the entry of the occupants into the conditioned space, the total hours spent in the conditioned space and type of the building. Values of CLF have been obtained for different types of buildings and have been tabulated in ASHRAE handbooks.

Since the latent heat gain from the occupants is instantaneous the CLF for latent heat gain is 1.0, thus the latent heat gain due to occupants is given by:

$$Q_{l, \text{occupants}} = (\text{No. of people}) \cdot (\text{Latent heat gain / person})$$

b) Load due to lighting: Lighting adds sensible heat to the conditioned space. Since the heat transferred from the lighting system consists of both radiation and convection, a Cooling Load Factor is used to account for the time lag. Thus the cooling load due to lighting system is given by:

$$Q_{s, \text{lighting}} = (\text{Installed wattage}) (\text{Usage Factor}) (\text{Ballast factor}) \text{CLF}$$

The usage factor accounts for any lamps that are installed but are not switched on at the time at which load calculations are performed. The ballast factor takes into account the load imposed by ballasts used in fluorescent lights. A typical ballast factor value of 1.25 is taken for fluorescent lights, while it is equal to 1.0 for incandescent lamps. The values of CLF as a function of the number of hours after the lights are turned on, type of lighting fixtures and the hours of operation of the lights are available in the form of tables in ASHRAE handbooks.

c) Internal loads due to equipment and appliances: The equipment and appliances used in the conditioned space may add both sensible as well as latent loads to the conditioned space.

Again, the sensible load may be in the form of radiation and/or convection. Thus the internal sensible load due to equipment and appliances is given by:

$$Q_{s, \text{appliances}} = (\text{Installed wattage}) \cdot (\text{Usage Factor}) \cdot \text{CLF}$$

The installed wattage and usage factor depend on the type of the appliance or equipment. The CLF values are available in the form of tables in ASHARE handbooks.

The latent load due to appliances is given by:

$$Q_{l, \text{appliance}} = (\text{Installed wattage}) \cdot (\text{Latent heat fraction})$$

For other equipment such as computers, printers etc, the load is in the form of sensible heat transfer and is estimated based on the rated power consumption. The CLF value for these equipment may be taken as 1.0 as the radiative heat transfer from these equipment is generally negligible due to smaller operating temperatures. When the equipment are run by electric motors which are also kept inside the conditioned space, then the efficiency of the electric motor must be taken into account. Though the estimation of cooling load due to appliance and equipment appears to be simple as given by the equations, a large amount of uncertainty is introduced on account of the usage factor and the difference between rated (nameplate) power consumption at full loads and actual power consumption at part loads. Estimation using nameplate power input may lead to overestimation of the loads, if the equipment operates at part load conditions most of the time.

If the conditioned space is used for storing products (**e.g. cold storage**) or for carrying out certain processes, then the sensible and latent heat released by these specific products and or the processes must be added to the internal cooling loads. The sensible and latent heat release rate of a wide variety of live and dead products commonly stored in cold storages are available in air conditioning and refrigeration handbooks. Using these tables, one can estimate the required cooling capacity of cold storages.

Thus using the above equations one can estimate the sensible ($Q_{s,r}$), latent ($Q_{l,r}$) and total cooling load ($Q_{t,r}$) on the buildings. Since the load due to sunlit surfaces varies as a function of solar time, it is preferable to calculate the cooling loads at different solar times and choose the maximum load for estimating the system capacity. From the sensible and total cooling loads one can calculate the Room Sensible Heat Factor (RSHF) for the building. From the RSHF value and the required indoor conditions one can draw the RSHF line on the psychrometric chart and fix the condition of the supply air.

Humidification

A humidifier is a device that increases humidity (moisture) in a single room or an entire building. In the home, point-of-use humidifiers are commonly used to humidify a single room, while whole-house or furnace humidifiers, which connect to a home's HVAC system, provide humidity to the entire house. Medical ventilators often include humidifiers for increased patient comfort. Large humidifiers are used in commercial, institutional, or industrial contexts, often as part of a larger HVAC system.

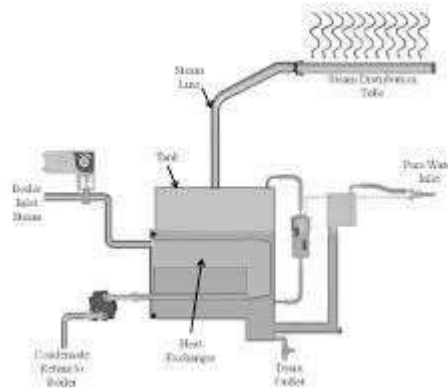

Industrial humidifiers are used when a specific humidity level must be maintained to prevent static electricity buildup, preserve material properties, and ensure a comfortable and healthy environment for workers or residents.

Static problems are prevalent in industries such as packaging, printing, paper, plastics, textiles, electronics, automotive manufacturing and pharmaceuticals. Friction can produce static buildup and sparks when humidity is below 45% relative humidity (RH). Between 45% and 55% RH, static builds up at reduced levels, while humidity above 55% RH ensures that static will never build up. The American Society of Heating, Refrigerating and Air Conditioning Engineers (ASHRAE) has traditionally recommended a range of 45–55% RH in data centers to prevent sparks that can damage IT equipment.^[8] Humidifiers are also used by manufacturers of semiconductors and in hospital operating rooms.

Printers and paper manufacturers use humidifiers to prevent shrinkage and paper curl. Humidifiers are needed in cold storage rooms to preserve the freshness of food against the dryness caused by cold temperatures. Art museums use humidifiers to protect sensitive works of art, especially in exhibition galleries, where they combat the dryness caused by heating for the comfort of visitors during winter.

Dehumidification

A **dehumidifier** is an electrical appliance which reduces and maintains the level of humidity in the air, usually for health or comfort reasons, or to eliminate musty odor and to prevent the growth of mildew by extracting water from the air. It can be used for

household, commercial, or industrial applications. Large dehumidifiers are used in commercial buildings such as indoor ice rinks and swimming pools, as well as manufacturing plants or storage warehouses.

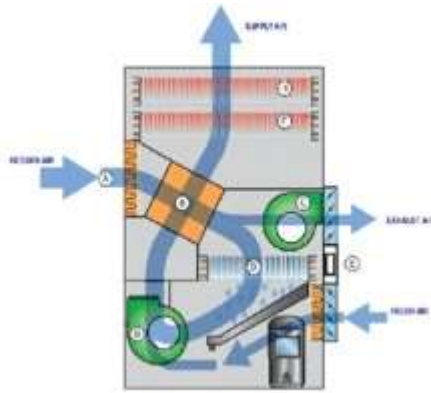

Electric refrigeration dehumidifiers are the most common type of dehumidifiers. They work by drawing moist air over a refrigerated evaporator with a fan. There are 3 main types of evaporators. They are coiled tube, fin and tube, and microchannel technology.

The cold evaporator coil of the refrigeration device condenses the water, which is removed, and then the air is reheated by the condenser coil. The now dehumidified, rewarmed air is released into the room. This process works most effectively at higher ambient temperatures with a high dew point temperature. In cold climates, the process is less effective. Highest efficiency is reached above 20 °C (68 °F) and 45% relative humidity. This relative humidity value is higher if the temperature of the air is lower.[\[citation needed\]](#).

This type of dehumidifier differs from a standard air conditioner in that both the evaporator and the condenser are placed in the same air path. A standard air conditioner transfers heat energy out of the room because its condenser coil releases heat outside. However, since all components of the dehumidifier are in the same room, no heat energy is removed. Instead, the electric power consumed by the dehumidifier remains in the room as heat, so the room is actually heated, just as by an electric heater that draws the same amount of power.

In addition, if water is condensed in the room, the amount of heat previously needed to evaporate that water also is re-released in the room (the latent heat of vaporization). The dehumidification process is the inverse of adding water to the room with an evaporative cooler, and instead releases heat. Therefore, an in-room dehumidifier will always warm the room and reduce the relative humidity indirectly, as well as reducing the humidity more directly, by condensing and removing water.

Air Conditioning Filter

Air conditioning filter in the house or offices is used to remove solid contaminants such as smoke, pollen, dust, grease and pollen to ensure better air quality for the occupants. A

study showed that indoor pollution is common these days due to the chemicals that are used in household furnishings and various goods.

These filters are usually placed on the return air of the air conditioning system. The air that contained the contaminants are trapped here. Clean air is then discharged into the space together with the cool air.

Types of Air Conditioning Filter

Plastic mesh filters are commonly installed at the return air of most indoor unit of room or window air conditioner. They trapped bigger particles of dust and should be cleaned every two weeks and more frequent if the space being conditioned is polluted.

If you look at the manual, they are easy to take out from the unit. Wash thoroughly with water and household dish washing detergent to remove dirt that stuck to it. Leave to dry and put back.

Electrostatic air filters are commonly placed in the return air of the air conditioner unit where the air is subjected to high voltage up to 12kV between two plates. The ionized particles are then drawn to the grounded plates. The electronic circuit used to generate the voltage is usually embedded on the control printed circuit board or a separate module.

Carbon and Adhesive filters are other types used. Carbon type is made of activated carbon that is effective in removing odour causing gases and bacteria. Adhesive type is made of cotton and fiber glass material coated with adhesive oil or liquid which trapped the particles.



Grills:

Primarily, the damper allows for the amount of hot or cool **air** into a room to be controlled, providing for more accurate control over room temperature. Dampers also allow for **air** to be shut off in unused rooms, improving the efficiency of the **HVAC** system. Dampers can also help adjust a **HVAC** system for seasonal **use**.



Fans and blowers:

We have learned in [Air Conditioner Parts](#) that fans function as **air movers**. This equipment will enable forced convection to occur, thus improving the heat transfer rate.

In addition to that, it makes compact design of evaporator and condenser, possible. Depending on natural convection would otherwise mean very large evaporator and condenser design. Not only that, you'll have to wait almost forever before cool air reaches you.

Therefore, function of air conditioner fans and blowers is not negligible thing. Not now, not forever.

Blowers have the exact same function as a fan. Only the construction is different. Fans are normally used at condensing units, while blowers are used for evaporation units.

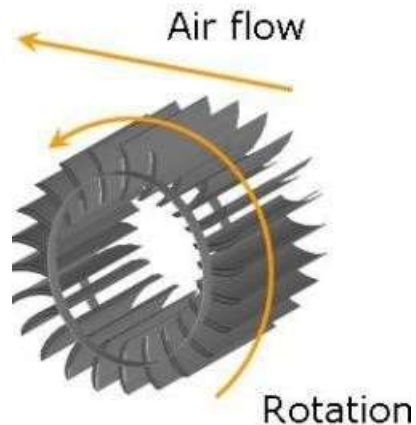

The characteristics of fans and blowers are quite similar to that of compressors.

These equipments have,

- **maximum rotational speed** – limited by the driver's speed and power, and
- **maximum pressure difference** between inlet, and outlet of the fluid motion – limited by the driver's power

Heat Pump:

A heat pump is a device that transfers heat energy from a source of heat to what is called a heat sink. Heat pumps move thermal energy in the opposite direction of spontaneous heat transfer, by absorbing heat from a cold space and releasing it to a warmer one. A heat pump uses a small amount of external power to accomplish the work of transferring energy from the heat source to the heat sink.^[1] The most common design of a heat pump involves four main components – a condenser, an expansion valve, an evaporator and a compressor. The heat transfer medium circulated through these components is called refrigerant

While air conditioners and freezers are familiar examples of heat pumps, the term "heat pump" is more general and applies to many HVAC (heating, ventilating, and air conditioning) devices used for space heating or space cooling. When a heat pump is used for heating, it employs the same basic refrigeration-type cycle used by an air conditioner or a refrigerator, but in the opposite direction – releasing heat into the conditioned space rather than the surrounding environment. In this use, heat pumps generally draw heat from the cooler external air or from the ground.^[3]

In heating mode, heat pumps are three to four times more effective at heating than simple electrical resistance heaters using the same amount of electricity. However, the typical cost of installing a heat pump is also higher than that of a resistance heater.

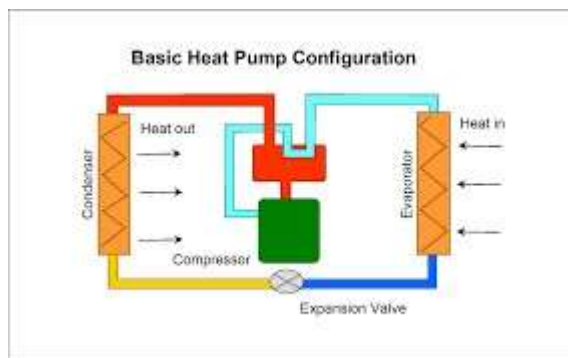

For climates with moderate heating and cooling needs, heat pumps offer an energy-efficient alternative to furnaces and air conditioners. Like your refrigerator, heat pumps use electricity to move heat from a cool space to a warm space, making the cool space cooler and the warm space warmer. During the heating season, heat pumps move heat from the cool outdoors into your

warm house and during the cooling season, heat pumps move heat from your cool house into the warm outdoors. Because they move heat rather than generate heat, heat pumps can provide equivalent space conditioning at as little as one quarter of the cost of operating conventional heating or cooling appliances.

There are three types of heat pumps: air-to-air, water source, and geothermal. They collect heat from the air, water, or ground outside your home and concentrate it for use inside.

The most common type of heat pump is the air-source heat pump, which transfers heat between your house and the outside air. Today's heat pump can reduce your electricity use for heating by approximately 50% compared to electric resistance heating such as furnaces and baseboard heaters. High-efficiency heat pumps also dehumidify better than standard central air conditioners, resulting in less energy usage and more cooling comfort in summer months. Air-source heat pumps have been used for many years in nearly all parts of the United States, but until recently they have not been used in areas that experienced extended periods of subfreezing temperatures. However, in recent years, air-source heat pump technology has advanced so that it now offers a legitimate space heating alternative in colder regions.

For homes without ducts, air-source heat pumps are also available in a ductless version called a mini-split heat pump. In addition, a special type of air-source heat pump called a "reverse cycle chiller" generates hot and cold water rather than air, allowing it to be used with radiant floor heating systems in heating mode.

Geothermal (ground-source or water-source) heat pumps achieve higher efficiencies by transferring heat between your house and the ground or a nearby water source. Although they cost more to install, geothermal heat pumps have low operating costs because they take advantage of relatively constant ground or water temperatures. Geothermal (or ground source) heat pumps have some major advantages. They can reduce energy use by 30%-60%, control humidity, are sturdy and reliable, and fit in a wide variety of homes. Whether a geothermal heat pump is appropriate for you will depend on the size of your lot, the subsoil, and the landscape. Ground-source or water-source heat pumps can be used in more extreme climates than air-source heat pumps, and customer satisfaction with the systems is very high.

A new type of heat pump for residential systems is the absorption heat pump, also called a gas-fired heat pump. Absorption heat pumps use heat as their energy source, and can be driven with a wide variety of heat sources.

References:

1. <https://nptel.ac.in/courses/112105129/>
2. C.P. Arora, "Refrigeration & Air Conditioning", Tata McGraw-Hill Education, 3rd Edition, 2010.
3. S.C. Arora & Domkundwar "A Course in Refrigeration and Air conditioning", Dhanpatrai Publications, 3rd edition, 1980.